



DISPLAYS THAT DO THE TALKING.

[www.momaitilesdisplay.com](http://www.momaitilesdisplay.com)

## About Us

Momai Tiles Display is a trusted manufacturer of modern and durable tile display stands for showrooms and retail spaces. We create smart and functional display solutions that help businesses present tiles in an organized and attractive way. Our focus on quality, innovation, and customer satisfaction allows us to deliver reliable products for the ceramic industry.

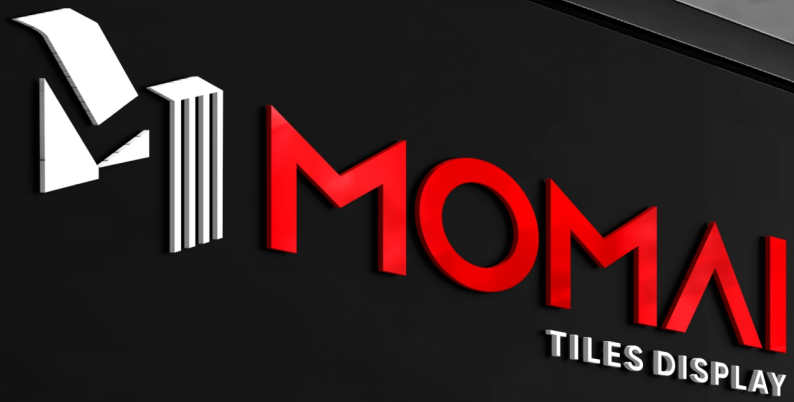

# Vision

At Momai Tiles Display, our vision is to become a trusted global leader in innovative tile display stand manufacturing by delivering modern, durable, and visually impactful display solutions that elevate showroom experiences. We aim to help tile brands, retailers, and distributors present their products with elegance, efficiency, and professionalism while continuously setting new standards in design, quality, and functionality.

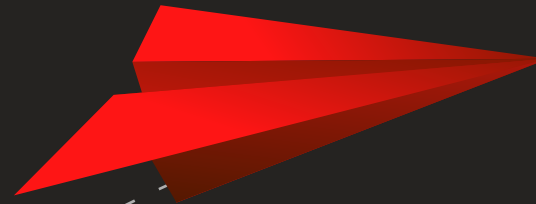

# Mission

Our mission is to manufacture high-quality tile display stands that combine strength, smart engineering, and aesthetic appeal to meet the evolving needs of the ceramic and tile industry. We are committed to providing customized solutions, reliable service, timely delivery, and long-term value to our clients while building strong relationships through innovation, craftsmanship, and customer satisfaction.

**SMALL**

STANDS

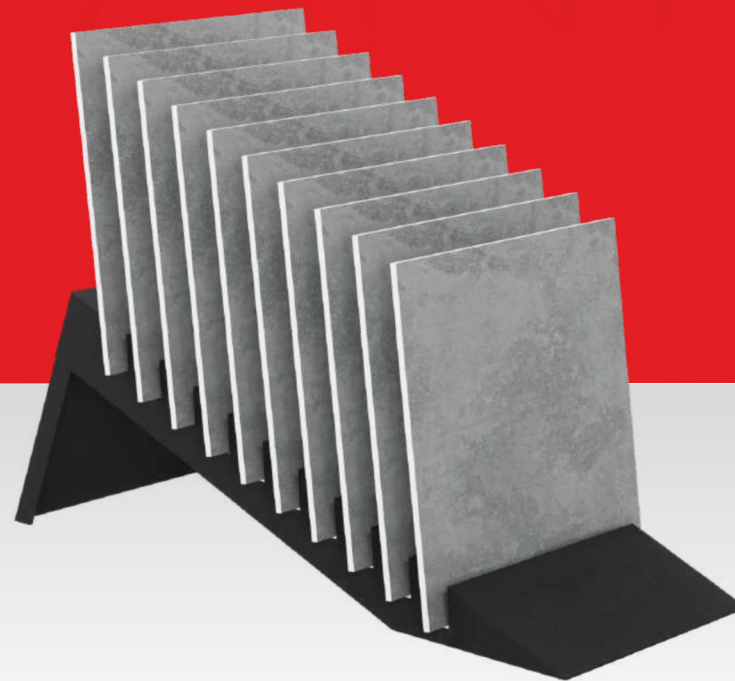

**ADAPTIVE SIZE**

POWERFUL DISPLAY THAT GRABS ATTENTION

[www.momaitilesdisplay.com](http://www.momaitilesdisplay.com)



# SMALL STANDS

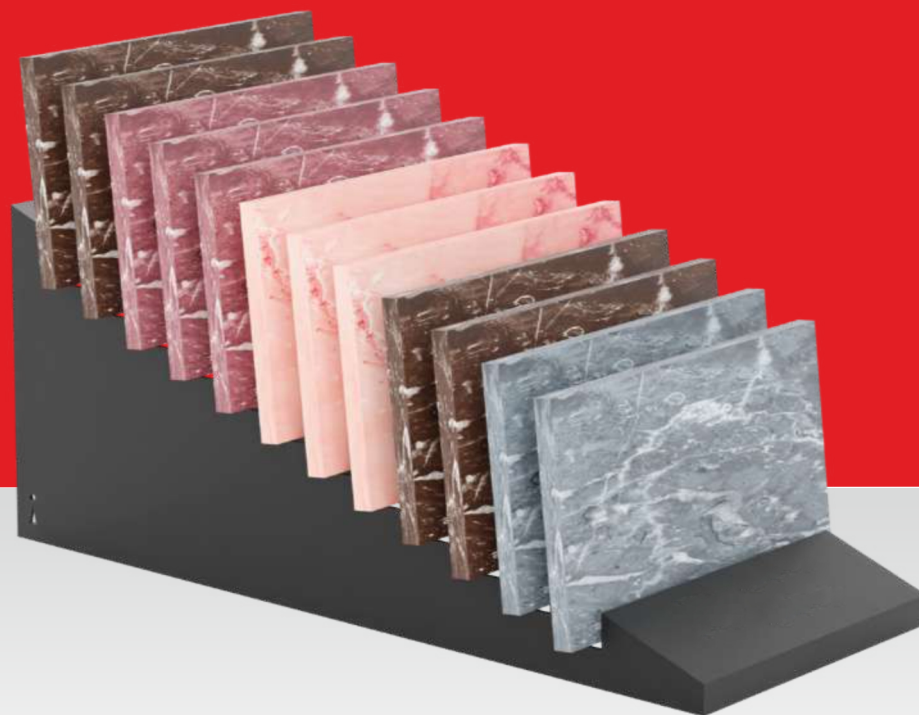

# SMALL STANDS



## MATERIAL DETAILS

TYPE : MS PIPE

COATING : POWDER COATING

PLATE THICKNESS : 1.5 MM

COLOUR



## TOP VIEW

← 180 →

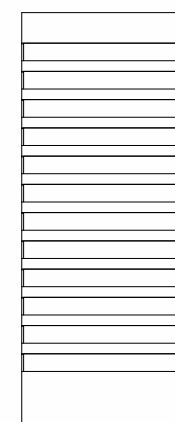

## SIDE VIEW

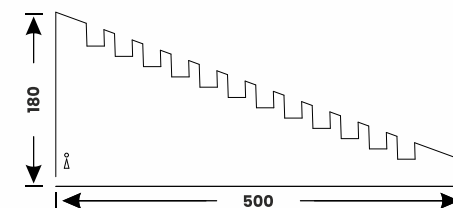

## TENY SERIES

CODE	STAND SIZE (H * L * W)	PANEL SIZE	TILE SIZE (L * W * T)	TILES QTY.	WEIGHT (KG)
PDS002A	200 * 550 * 150	-	300 * 150 * 15	11	03
			200 * 200 * 20	11	03
			100 * 200 * 15	11	03



# SMALL STANDS



# SMALL STANDS

## MATERIAL DETAILS

TYPE : MS PIPE

COATING : POWDER COATING

PLATE THICKNESS : 1.5 MM

COLOUR



SIDE VIEW

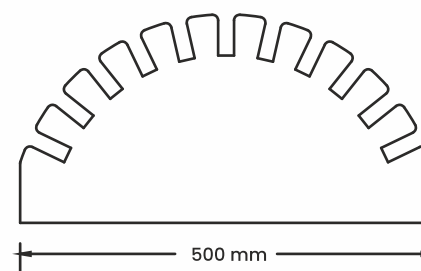

TOP VIEW



## TENY SERIES

CODE	STAND SIZE (H x L x W)	PANEL SIZE	TILE SIZE (L x W x T)	TILES QTY.	WEIGHT (KG)
M001	200 x 550 x 150	-	300 x 150 x 15	11	03
			200 x 200 x 20	11	03
			100 x 200 x 15	11	03



# SMALL STANDS



# SMALL STANDS



## MATERIAL DETAILS

TYPE : MS PIPE

COATING : POWDER COATING

PLATE THICKNESS : 1.5 MM

COLOUR



TOP VIEW

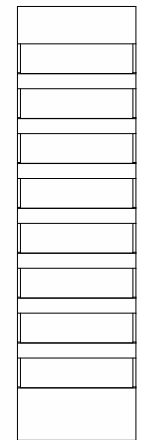

SIDE VIEW

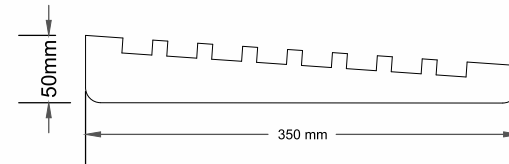

## TENY SERIES

CODE	STAND SIZE (H x L x W)	PANEL SIZE	TILE SIZE (L x W x T)	TILES QTY.	WEIGHT (KG)
M001	50 x 350 x 100	-	300 x 150 x 15	10	01
			200 * 200 * 20	10	01
			100 x 200 * 15	10	01



# SMALL STANDS



# SMALL STANDS

## MATERIAL DETAILS

TYPE : MS PIPE

COATING : POWDER COATING

PLATE THICKNESS : 1.5 MM

COLOUR



FRONT VIEW

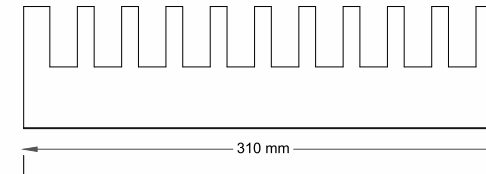

SIDE VIEW

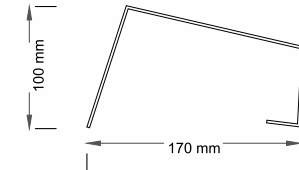

## TENY SERIES

CODE	STAND SIZE (H x L x W)	PANEL SIZE	TILE SIZE (L x W x T)	TILES QTY.	WEIGHT (KG)
M001	100 * 310 x 170	-	300 * 150 * 15	10	02
			200 * 200 * 20	10	02
			100 * 200 * 15	10	02



# SMALL STANDS



# SMALL STANDS

## MATERIAL DETAILS

TYPE : MS PIPE

COATING : POWDER COATING

PLATE THICKNESS : 1.5 MM

COLOUR



FRONT VIEW

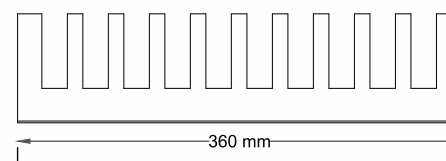

SIDE VIEW

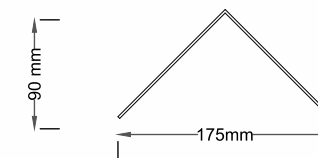

## TENY SERIES

CODE	STAND SIZE (H x L x W)	PANEL SIZE	TILE SIZE (L x W x T)	TILES QTY.	WEIGHT (KG)
M001	90 x 360 x 175	-	300 x 150 x 15	10	1.5
			200 x 200 x 20	10	1.5
			100 x 200 x 15	10	1.5



# SMALL STANDS



# SMALL STANDS

## MATERIAL DETAILS

TYPE : MS PIPE

COATING : POWDER COATING

PLATE THICKNESS : 02 MM

COLOUR



FRONT VIEW

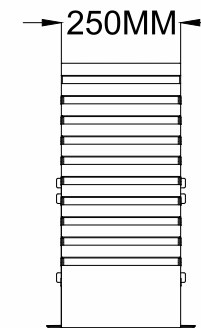

SIDE VIEW

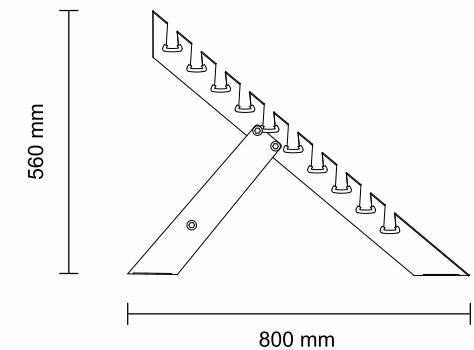

## TENY SERIES

CODE	STAND SIZE (H x L x W)	PANEL SIZE	TILE SIZE (L x W x T)	TILES QTY.	WEIGHT (KG)
M001	560 x 800 x 250	-	450 x 300 x 9	10	05
M002	560 x 800 x 380	-	200 x 200 x 9	10	07
M003	560 x 800 x 508	-	1200 x 600 x 9	10	10



# SMALL STANDS

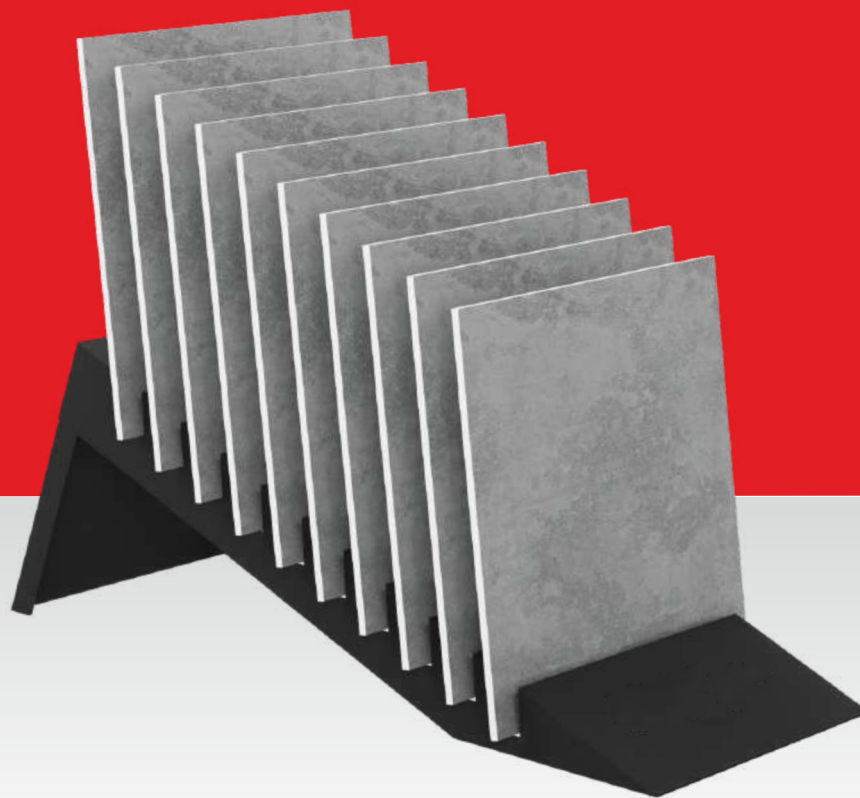

# SMALL STANDS

## MATERIAL DETAILS

**TYPE :** MS PIPE

**COATING :** POWDER COATING

**PLATE THICKNESS :** 02 MM

**WEIGHT :** 09 KG ( APPROX )

**COLOUR**

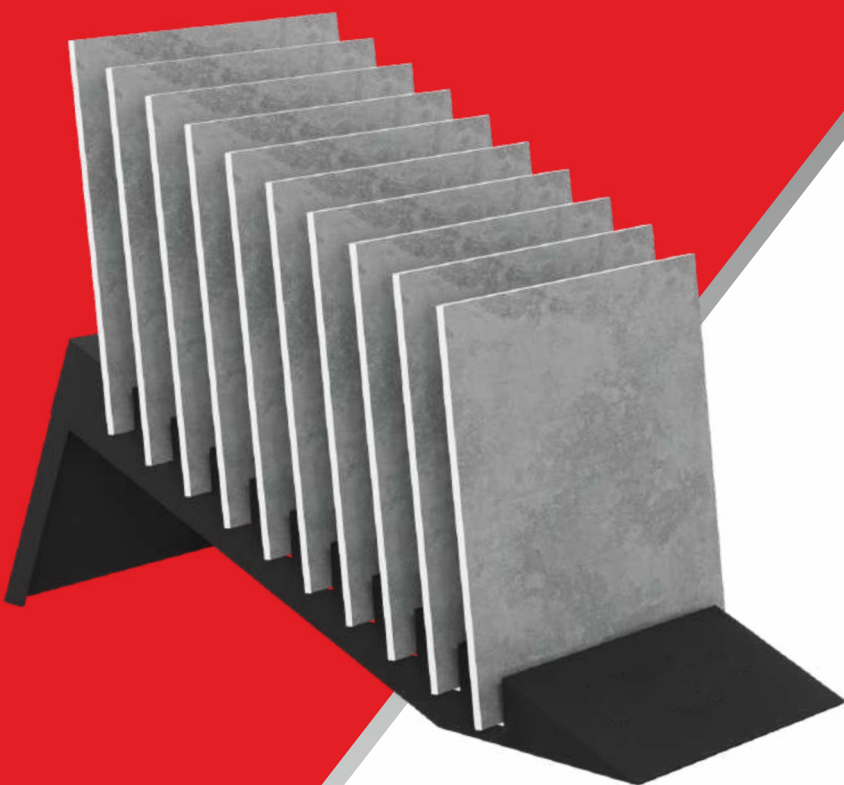

FRONT VIEW

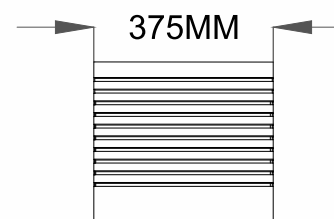

SIDE VIEW

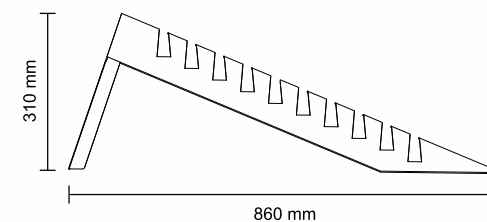

### TENY SERIES

CODE	STAND SIZE (H x L x W)	PANEL SIZE	TILE SIZE (L x W x T)	TILES QTY.	WEIGHT (KG)
M001	310 x 860 x 250	-	450 x 300 x 9	10	05
M002	310 x 860 x 375	-	200 x 200 x 09	10	07
M003	310 x 860 x 508	-	1200 x 600 x 9	10	10



# SMALL STANDS

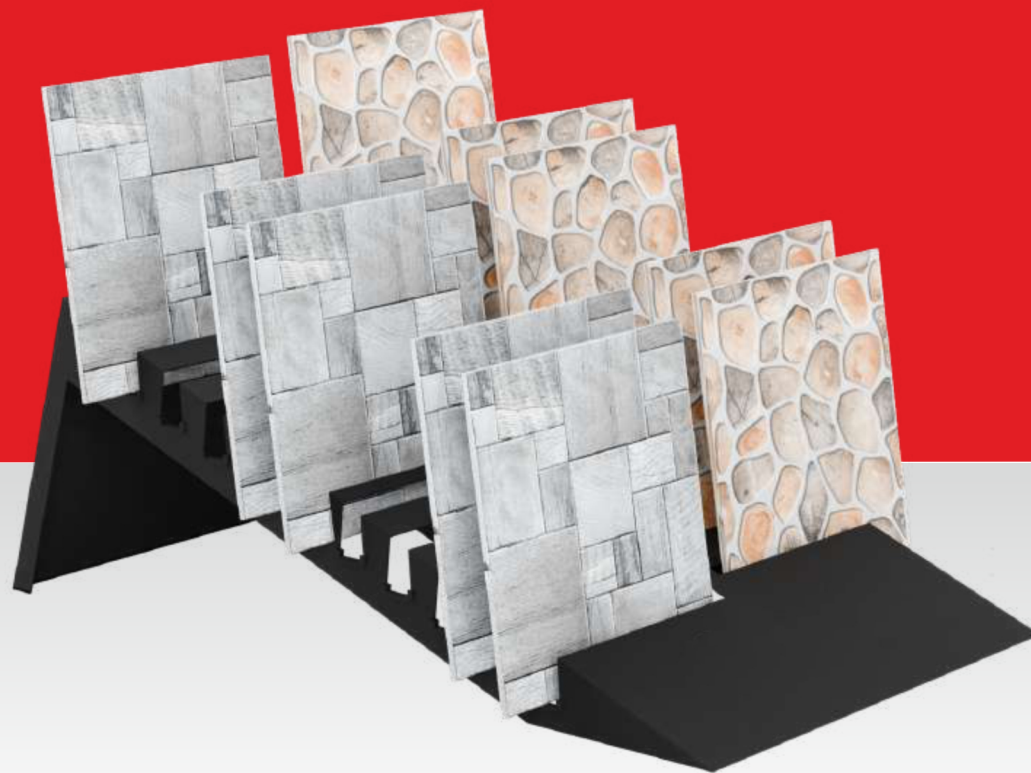

# SMALL STANDS

## MATERIAL DETAILS

TYPE : MS SHEET

COATING : POWDER COATING

PLATE THICKNESS : 02 MM

WEIGHT : 12 KG ( APPROX )

COLOUR



SIDE VIEW

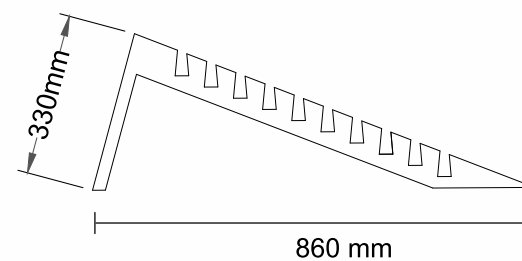

FRONT VIEW

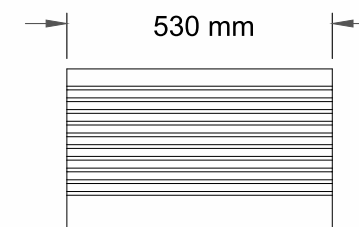

## TENY SERIES

CODE	STAND SIZE (H x L x W)	PANEL SIZE	TILE SIZE (L x W x T)	TILES QTY.	WEIGHT (KG)
M001	330 x 870 x 390	-	300 x 300 x 9	20	07
M002	330 x 870 x 530	-	300 x 450 x 9	20	12
			300 x 600 x 9		
			300 x 900 x 9		



# SMALL STANDS



# SMALL STANDS

## MATERIAL DETAILS

TYPE : MS SHEET

COATING : POWDER COATING

PLATE THICKNESS : 02 MM

COLOUR



SIDE VIEW

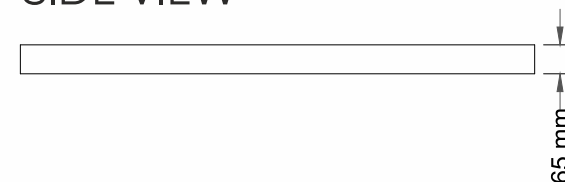

TOP VIEW

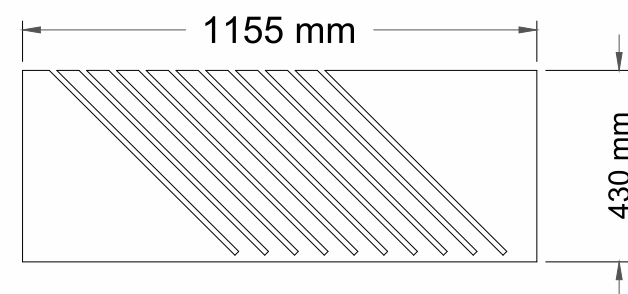

## TENY SERIES

CODE	STAND SIZE (H x L x W)	PANEL SIZE	TILE SIZE (L x W x T)	TILES QTY.	WEIGHT (KG)
M001	65 x 1155 x 430	-	300 x 600 x 9	10	12
M002	65 x 1450 x 430	-	600 x 600 x 9	15	15
			600 x 1200 x 9		
			800 x 1600 x 9		
			1200 x 1800 x 9		



# SMALL STANDS

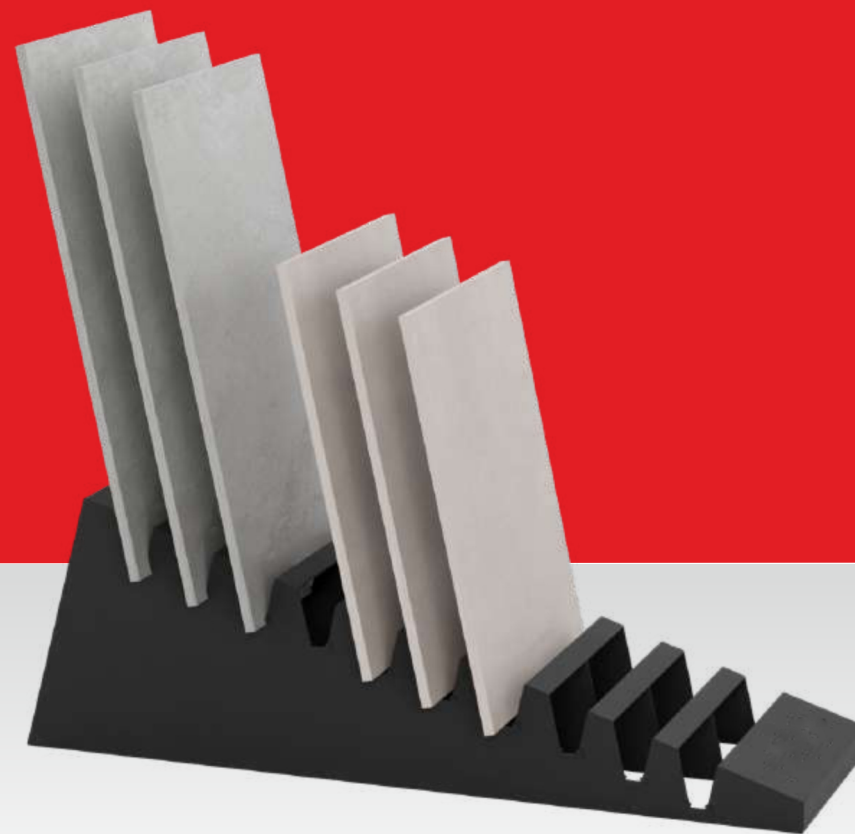

# SMALL STANDS

## MATERIAL DETAILS

TYPE : MS SHEET

COATING : POWDER COATING

PLATE THICKNESS : 02 MM

WEIGHT : 19 KG ( APPROX )

COLOUR

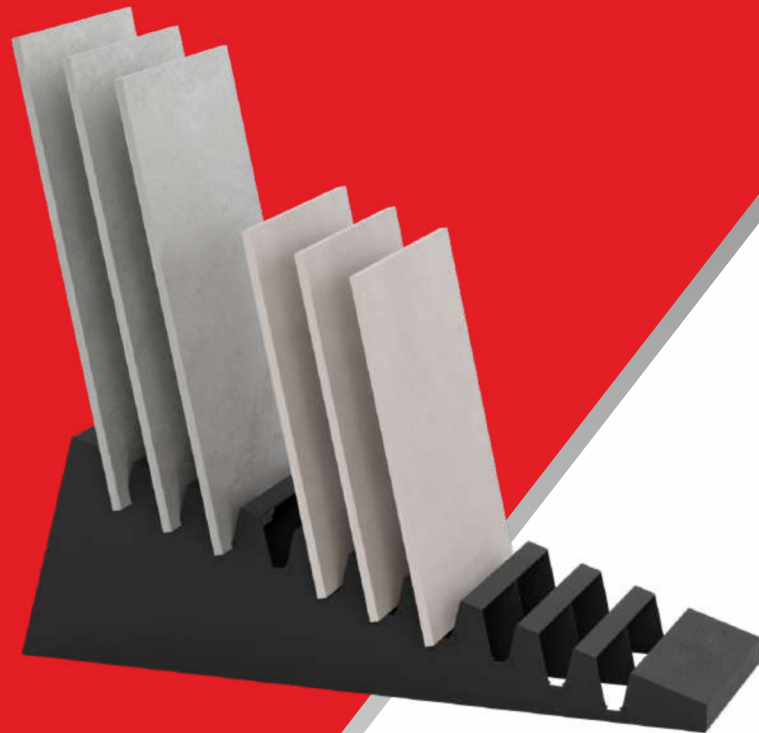

SIDE VIEW

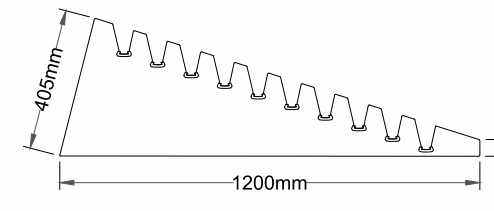

TOP VIEW

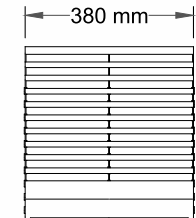

## TENY SERIES

CODE	STAND SIZE (H * L * W)	PANEL SIZE	TILE SIZE (L * W * T)	TILES QTY.	WEIGHT (KG)
M001	405 x 1200 x 390	-	600 x 600 x 20	10	26
			600 x 1200 x 20		
			800 x 2400 x 20		
			800 x 800 x 20		
			900 x 900 x 20		



# SMALL STANDS



# SMALL STANDS

## MATERIAL DETAILS

TYPE : MS PIPE

COATING : POWDER COATING

PLATE THICKNESS : 1.5 MM

WEIGHT : 09 KG ( APPROX )

COLOUR



SIDE VIEW

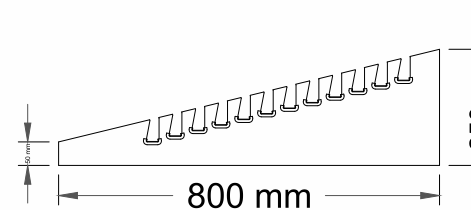

TOP VIEW

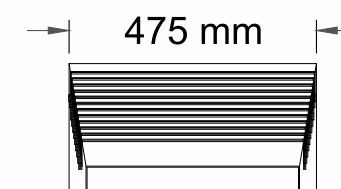

## TENY SERIES

CODE	STAND SIZE (H * L * W)	PANEL SIZE	TILE SIZE (L * W * T)	TILES QTY.	WEIGHT (KG)
M001	250 x 860 x 250	-	450 x 300 x 9	10	05
M002	250 x 860 x 375	-	600 x 600 x 9	10	10
M003	310 x 860 x 508	-	1200 x 600 x 9	10	12
			1600 x 800 x 9		
			1800 x 900 x 9		



# SMALL STANDS



# SMALL STANDS

## MATERIAL DETAILS

**TYPE :** MS PIPE, SHEET, PLYWOOD, CARPET

**COATING :** POWDER COATING

**MDF THICKNESS :** 12 MM

**WEIGHT :** 25 KG ( APPROX )

**COLOUR**



**SIDE VIEW**

**TOP VIEW**

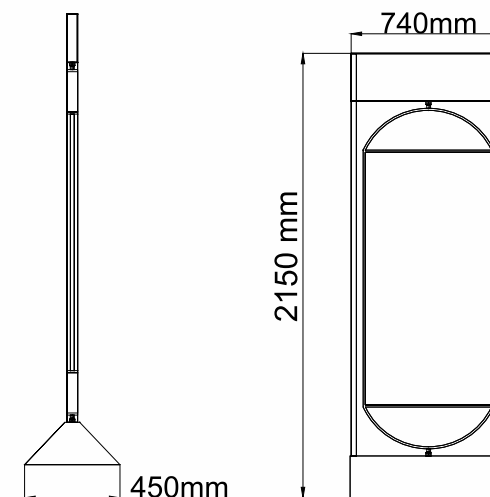

## TENY SERIES

CODE	STAND SIZE (H x L x W)	PANEL SIZE	TILE SIZE (L x W x T)	TILES QTY.	WEIGHT (KG)
	2130 x 740 x 450	-	600 x 1200 x 9	02	25



# SMALL STANDS



# SMALL STANDS

## MATERIAL DETAILS

TYPE : MDF

COATING : POWDER COATING

MDF THICKNESS : 12 MM

WEIGHT : 9 KG ( APPROX )

COLOUR



SIDE VIEW

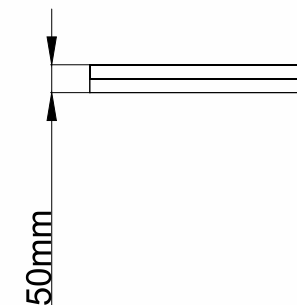

TOP VIEW

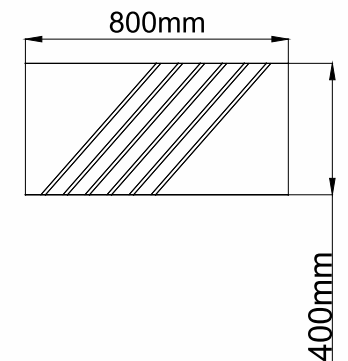

## TENY SERIES

CODE	STAND SIZE (H * L * W)	PANEL SIZE	TILE SIZE (L * W * T)	TILES QTY.	WEIGHT (KG)
	50 * 800 * 400	-	600 * 600 * 9	06	
			600 * 1200 * 9		



# SMALL STANDS



# SMALL STANDS



## MATERIAL DETAILS

**TYPE :** MS PIPE SHEET

**COATING :** POWDER COATING

**MDF THICKNESS :** 12 MM

**WEIGHT :** 20 KG ( APPROX )

**COLOUR**



SIDE VIEW

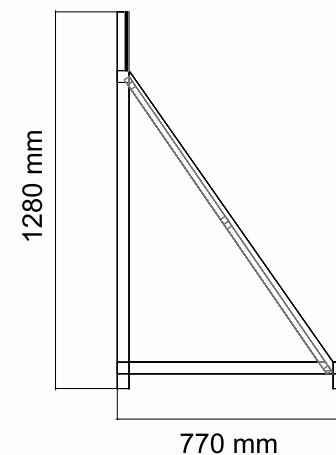

TOP VIEW

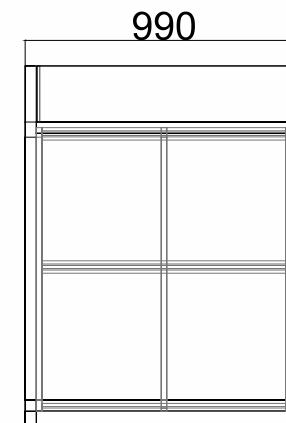

### TENY SERIES

CODE	STAND SIZE (H x L x W)	PANEL SIZE	TILE SIZE (L x W x T)	TILES QTY.	WEIGHT (KG)
	1282 x 990 x 774	-	-	01	20



# SMALL STANDS



# SMALL STANDS



## MATERIAL DETAILS

TYPE : MS PIPE & SHEET

COATING : POWDER COATING

OUTER BODY FRAME PIPE : 20 X 20 X 1.2 MM

COLOUR



SIDE VIEW

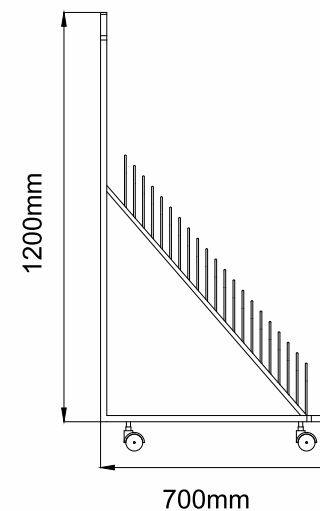

TOP VIEW

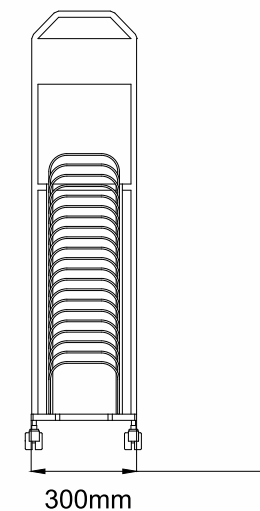

## SMALL STAND SERIES

CODE	STAND SIZE (H x L x W)	PANEL SIZE	TILE SIZE (L x W x T)	TILES QTY.	WEIGHT (KG)
M001	1190 x 680 x 310	-	300 x 300 x 09	17	10
M002	1190 x 680 x 510	-			10



# SMALL STANDS



# SMALL STANDS



## MATERIAL DETAILS

**TYPE :** MS PIPE & SHEET

**COATING :** POWDER COATING

**OUTER BODY FRAME PIPE :** 20 X 20 X 1.2 MM

**WEIGHT :** 20 X 20 X 1.2 MM

**COLOUR**



SIDE VIEW

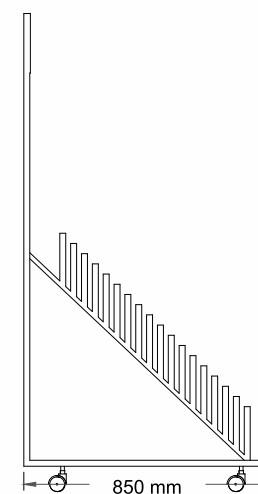

TOP VIEW

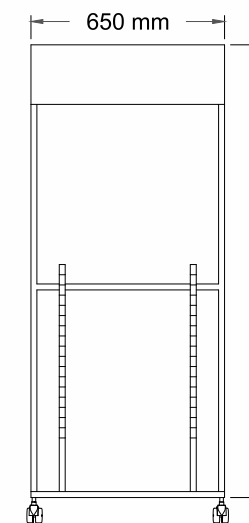

## SMALL STAND SERIES

CODE	STAND SIZE (H x L x W)	PANEL SIZE	TILE SIZE (L x W x T)	TILES QTY.	WEIGHT (KG)
M001	1520 x 830 x 650	-	300 x 300 x 09	17	15
			300 x 600 x 09		



# SMALL STANDS



# SMALL STANDS



## MATERIAL DETAILS

**TYPE :** MS PIPE

**COATING :** POWDER COATING

**OUTER BODY FRAME PIPE :** 20 X 20 X 1.2 MM

**WEIGHT :** 30 KG ( APPROX )

**COLOUR**



### SIDE VIEW

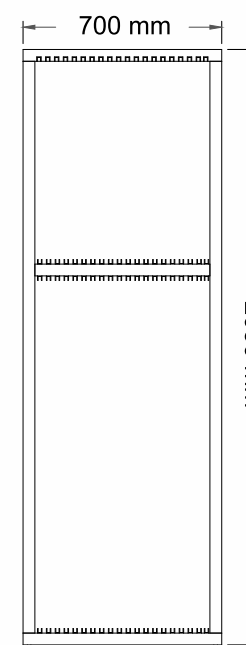

### TOP VIEW

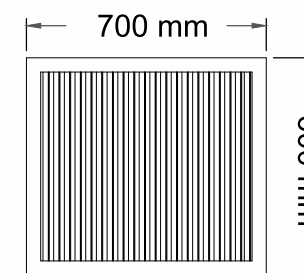

### SMALL STAND SERIES

CODE	STAND SIZE (H x L x W)	PANEL SIZE	TILE SIZE (L x W x T)	TILES QTY.	WEIGHT (KG)
M001	2020 x 700 x 610	-	600 x 600 x 09	20	50
			600 x 1200 x 09	20	



# SMALL STANDS



# SMALL STANDS



## MATERIAL DETAILS

TYPE : MS PIPE

COATING : POWDER COATING

OUTER BODY FRAME PIPE : 50 X 50 X 1.2 MM

WEIGHT : 15 KG ( APPROX )

COLOUR



TOP VIEW

SIDE VIEW

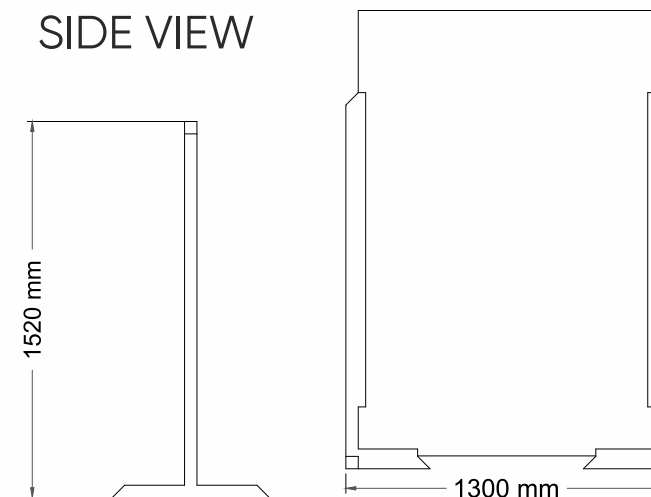

## SMALL STAND SERIES

CODE	STAND SIZE (H x L x W)	PANEL SIZE	TILE SIZE (L x W x T)	TILES QTY.	WEIGHT (KG)
M001	1520 x 1300 x 600	-	600 x 1200 x 09	02	15
			800 x 1600 x 09		
			1200 x 1800 x 09		
			1200 x 2400 x 09		



# SMALL STANDS



# SMALL STANDS



## MATERIAL DETAILS

TYPE : MS PIPE & SHEET

COATING : POWDER COATING

PLATE THICKNESS : 2 MM

COLOUR



SIDE VIEW

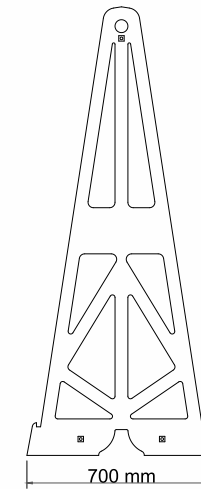

FRONT VIEW

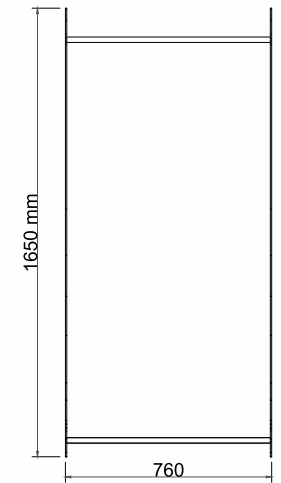

### SMALL STAND SERIES

CODE	STAND SIZE (H * L * W)	PANEL SIZE	TILE SIZE (L * W * T)	TILES QTY.	WEIGHT (KG)
M001	1650 x 780 x 700	-	800 x 1600 x 09	02	30
			1200 x 1800 x 09	02	



# SMALL STANDS



# SMALL STANDS

## MATERIAL DETAILS

TYPE : MS PIPE & SHEET

COATING : POWDER COATING

OUTER BODY FRAME PIPE : 1.5 MM

COLOUR



FRONT VIEW

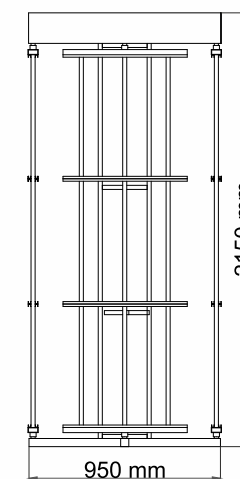

TOP VIEW

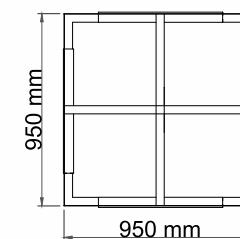

## SMALL STAND SERIES

CODE	STAND SIZE (H x L x W)	PANEL SIZE	TILE SIZE (L x W x T)	TILES QTY.	WEIGHT (KG)
M001	2150 x 950 x 950	-	600 x 600 x 09	24	30



# SMALL STANDS



# SMALL STANDS

## MATERIAL DETAILS

**TYPE :** MS PIPE + PLYWOOD + CARPET

**COATING :** POWDER COATING

**OUTER BODY FRAME PIPE :** 50 X 50 X 1.2 MM

**COLOUR**



FRONT VIEW

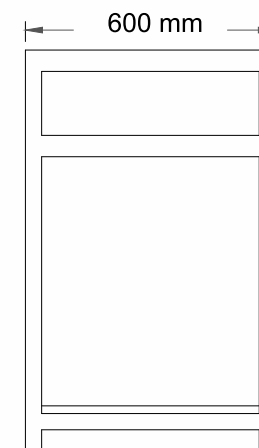

SIDE VIEW

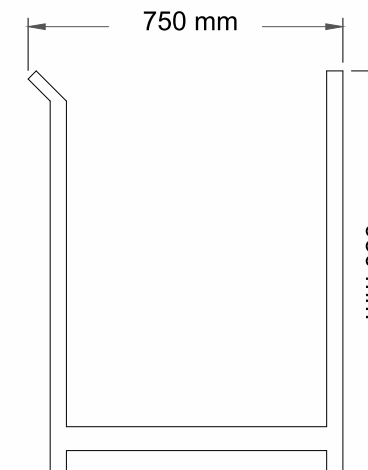

## SMALL STAND SERIES

CODE	STAND SIZE (H x L x W)	PANEL SIZE	TILE SIZE (L x W x T)	TILES QTY.	WEIGHT (KG)
M001	950 x 750 x 600	-	600 x 1200 x 09	15	15



# SMALL STANDS



# SMALL STANDS

## MATERIAL DETAILS

**TYPE :** MS PIPE & SHEET

**COATING :** POWDER COATING

**OUTER BODY FRAME PIPE :** 40 X 40 X 1.2 MM

**COLOUR**

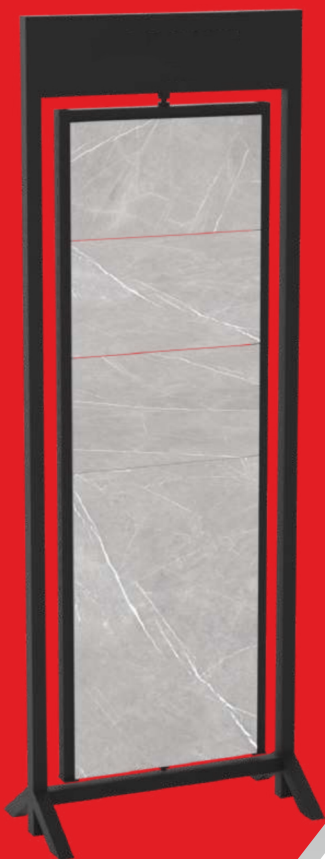

FRONT VIEW

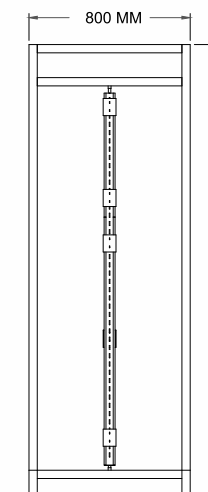

SIDE VIEW

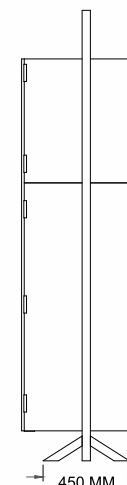

## SMALL STAND SERIES

CODE	STAND SIZE (H x L x W)	PANEL SIZE	TILE SIZE (L x W x T)	TILES QTY.	WEIGHT (KG)
M001	2200 x 800 x 450	600 x 1800	600 x 600 x 09	06	15
			600 x 1200 x 09	04	



# SMALL STANDS



# SMALL STANDS

## MATERIAL DETAILS

TYPE : MS PIPE

COATING : POWDER COATING

OUTER BODY FRAME PIPE : 32 X 32 X 1.2 MM

COLOUR

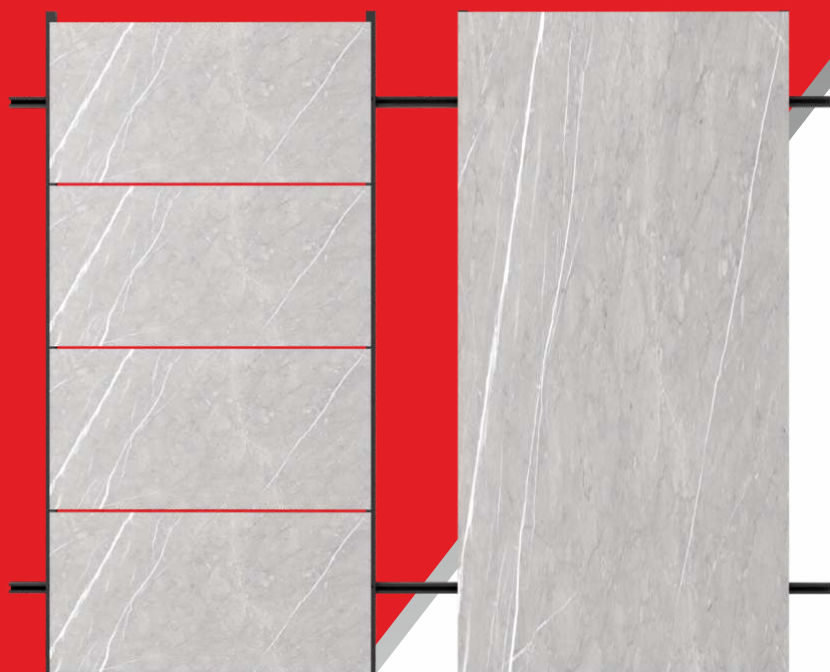

## FRONT VIEW

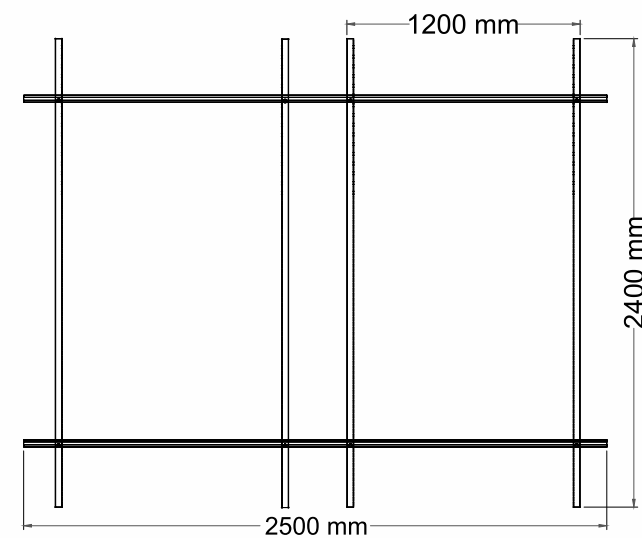

## WALL STAND SERIES

CODE	STAND SIZE (H x L x W)	PANEL SIZE	TILE SIZE (L x W x T)	TILES QTY.	WEIGHT (KG)
M001	2410 x 2500 x 50	-	600 x 600 x 09	06	15
			600 x 1200 x 09	04	



# SMALL STANDS



# SMALL STANDS

## MATERIAL DETAILS

**TYPE :** MS PIPE & PIPE

**COATING :** POWDER COATING

**OUTER BODY FRAME PIPE :** 32 X 32 X 1.2 MM

**COLOUR**

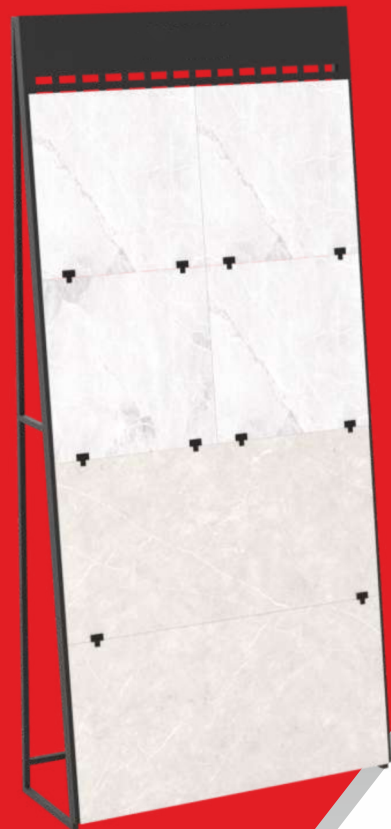

FRONT VIEW

SIDE VIEW

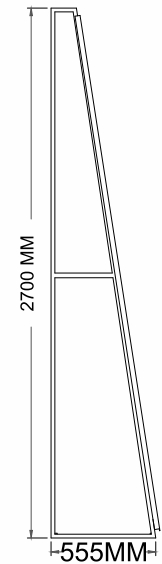
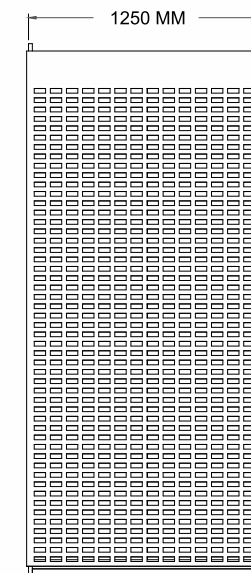

## GRILL STAND SERIES

CODE	STAND SIZE (H x L x W)	PANEL SIZE	TILE SIZE (L x W x T)	TILES QTY.	WEIGHT (KG)
M001	2700 x 1250 x 555	-	600 x 600 x 09	08	45
			600 x 1200 x 09	04	
			800 x 1600 x 09	03	
			1200 x 2400 x 09	01	



# SMALL STANDS



# SMALL STANDS

## MATERIAL DETAILS

TYPE : MS & PIPE & SHEET

COATING : POWDER COATING

PLATE THICKNESS : 2 MM

COLOUR



## FRONT VIEW

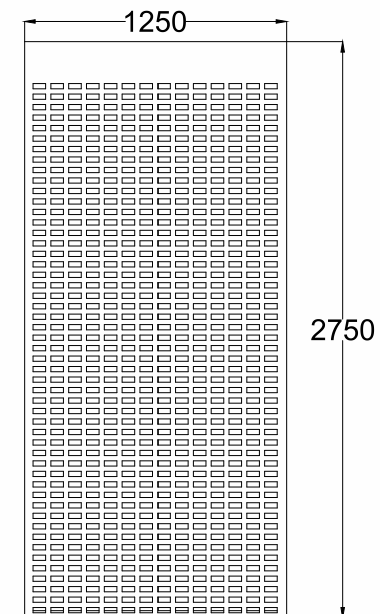

## SMALL STAND SERIES

CODE	STAND SIZE (H x L x W)	PANEL SIZE	TILE SIZE (L x W x T)	TILES QTY.	WEIGHT (KG)
M001	2700 x 1250 x 25	-	600 x 600 x 09	08	40
			600 x 1200 x 09	04	
			800 * 1600 x 09	03	
			1200 * 2400 x 09	01	



# SMALL STANDS



# SMALL STANDS

## MATERIAL DETAILS

**TYPE :** MS PIPE & PLYWOOD + CARPET

**COATING :** POWDER COATING

**OUTER BODY FRAME PIPE :** 50 X 50 X 1.2 MM

**COLOUR**



SIDE VIEW

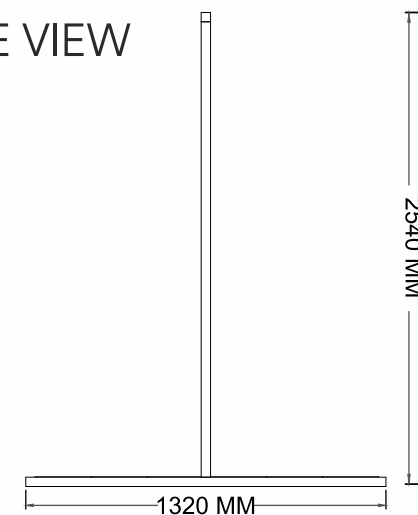

## T PANEL SERIES

CODE	STAND SIZE (H x L x W)	PANEL SIZE	TILE SIZE (L x W x T)	TILES QTY.	WEIGHT (KG)
M001	2540 x 1320 x 1320	1200 x 2400	300 x 300 x 09	32	70
			400 x 400 x 09	24	
			300 x 600 x 09	16	
			600 x 600 x 09	8	
			600 x 1200 x 09	4	
			1200 x 1200 x 09	2	
			1200 x 2400 x 09	1	



# SMALL STANDS



# SMALL STANDS



## MATERIAL DETAILS

TYPE : MS SHEET

COATING : POWDER COATING

THICKNESS : 1.5 MM

COLOUR



TOP VIEW

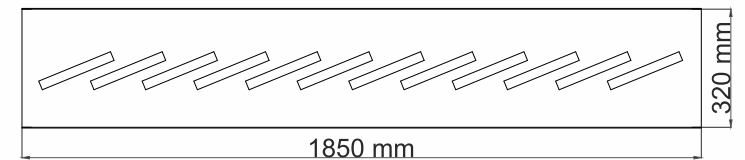

FRONT VIEW



## PLANK SERIES

CODE	STAND SIZE (H * L * W)	PANEL SIZE	TILE SIZE (L * W * T)	TILES QTY.	WEIGHT (KG)
M001	300 * 1850 * 300	-	200 * 1200 * 09	12	30
M002	150 * 830 * 250	-	200 * 1000 * 09	10	13
M003	80 * 425 * 200	-	200 * 900 * 09	10	05



# SMALL STANDS



# SMALL STANDS

## MATERIAL DETAILS

TYPE : MS SHEET

COATING : POWDER COATING

MDF THICKNESS : 1.5 MM

COLOUR



SIDE VIEW

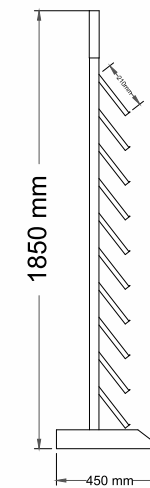

FRONT VIEW

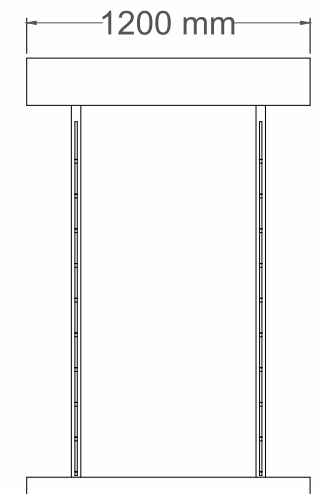

## PLANK SERIES

CODE	STAND SIZE (H * L * W)	PANEL SIZE	TILE SIZE (L * W * T)	TILES QTY.	WIEGHT (KG)
M001	1855 x 1200 x 450	-	200 x 1200 x 09	10	25
			200 x 1000 x 09		
			200 x 900 x 09		



# SMALL STANDS

# SMALL STANDS

## MATERIAL DETAILS

TYPE : MS SHEET

COATING : POWDER COATING

MDF THICKNESS : 02 MM

COLOUR



## SIDE VIEW

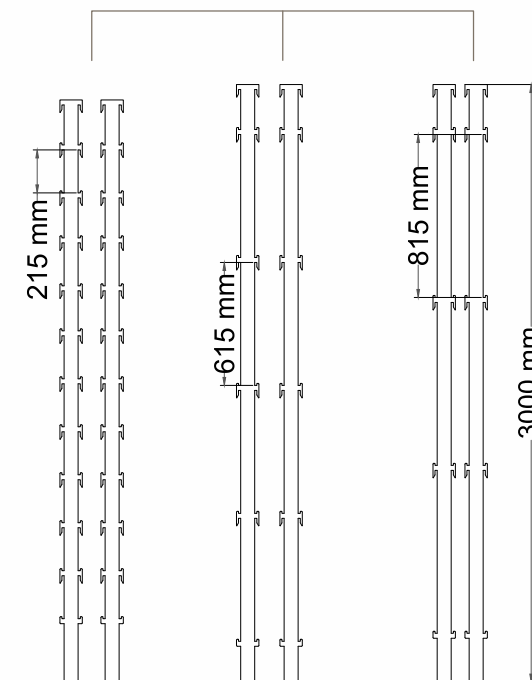

## WOODEN PLANK SERIES

CODE	STAND SIZE (H x L x W)	PANEL SIZE	TILE SIZE (L x W x T)	TILES QTY.	WEIGHT (KG)
M001	2990 x 1200 x 50	-	200 x 1200 x 09	10	04
			600 x 1200 x 09	04	04
			800 * 1600 * 09	03	



# SMALL STANDS



# SMALL STANDS

## MATERIAL DETAILS

TYPE : MDF

COATING : DECO PAINT

MDF THICKNESS : 18 MM

COLOUR



TOP VIEW

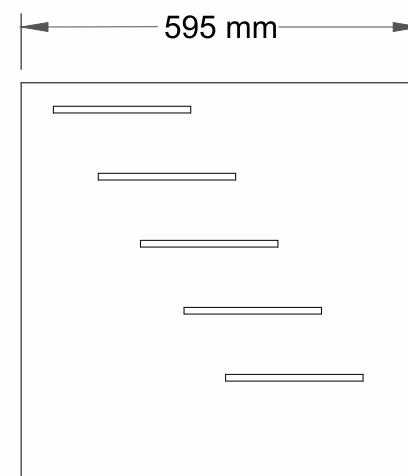

SIDE VIEW

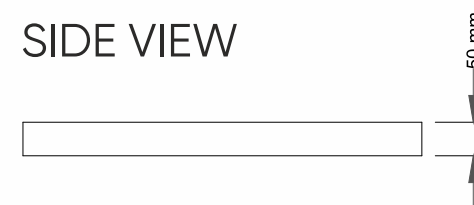

## WOODEN PLANK SERIES

CODE	STAND SIZE (H x L x W)	PANEL SIZE	TILE SIZE (L x W x T)	TILES QTY.	WEIGHT (KG)
M001	50 x 600 x 600	-	200 x 1200 x 09	05	8



# SMALL STANDS



# SMALL STANDS

## MATERIAL DETAILS

**TYPE :** MS PIPE & SHEET

**COATING :** POWDER COATING

**MDF THICKNESS :** 1.2 MM

**OUTER BODY FRAME PIPE :** 25 X 25 X 1.2 MM

**COLOUR**



SIDE VIEW

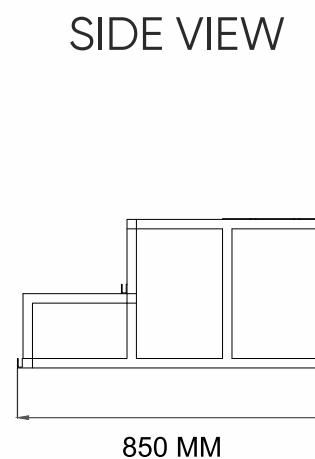

FRONT VIEW

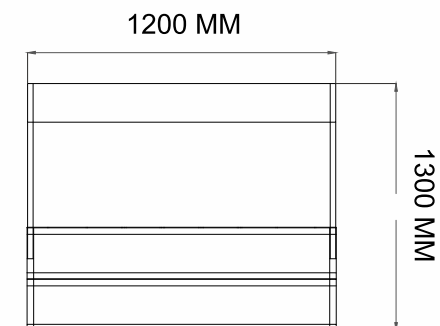

## STEPRISER SERIES

CODE	STAND SIZE (H x L x W)	PANEL SIZE	TILE SIZE (L x W x T)	TILES QTY.	WEIGHT (KG)
M001	1350 x 1200 x 835	-	300 x 400 x 09	10	15
			300 x 1200 x 09	10	

**360° GULATIYA**



**FLEXIBLE AT ITS BEST**

POWERFUL DISPLAY THAT GRABS ATTENTION

[www.momaitilesdisplay.com](http://www.momaitilesdisplay.com)



# 360° GULATIYA STANDS



# 360° GULATIYA STANDS

## MATERIAL DETAILS

**TYPE :** MS PIPE & SHEET + PLYWOOD + CARPET

**COATING :** POWDER COATING

**PANEL PIPE :** 50 X 10 X 1.6 MM

**OUTER BODY FRAME PIPE :** 50 X 50 X 1.2 MM

**COLOUR**



FRONT VIEW

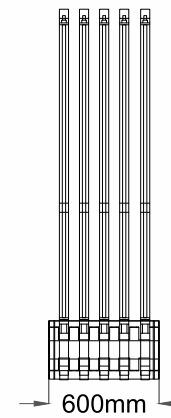

SIDE VIEW

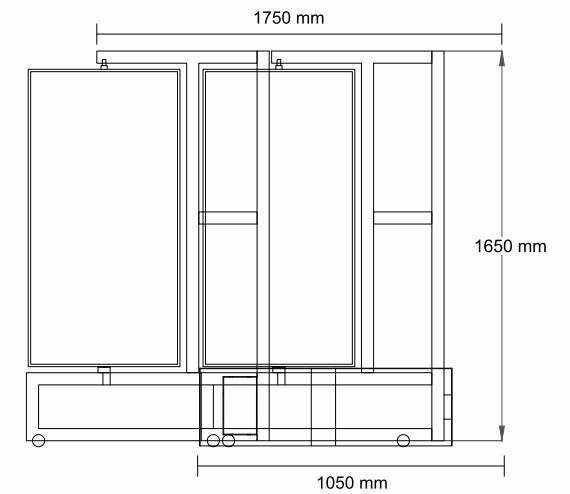

## 360° GULATIYA SERIES

CODE	STAND SIZE (H x L x W)	PANEL SIZE	TILE SIZE (L x W x T)	TILES QTY.	WEIGHT (KG)
M001	1750 x 600 x 1100	600 x 1200		10	100
	2150 x 600 x 1500	1000 x 1000		10	120
	1750 x 600 x 1700	1200 x 1200		10	140



# 360° GULATIYA STANDS



# 360° GULATIYA STANDS

## MATERIAL DETAILS

**TYPE :** MS PIPE

**COATING :** POWDER COATING

**MS PLATE :** 1.6 MM

**OUTER BODY FRAME PIPE :** 50 X 50 X 1.2 MM

**COLOUR**

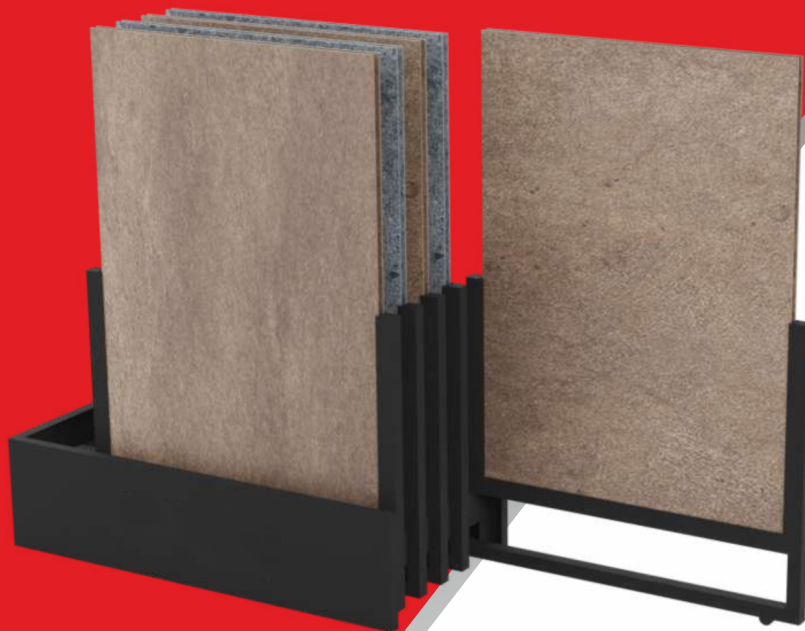

FRONT VIEW

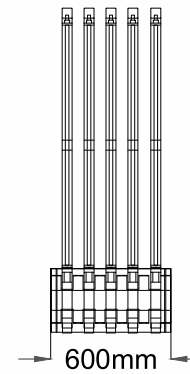

SIDE VIEW

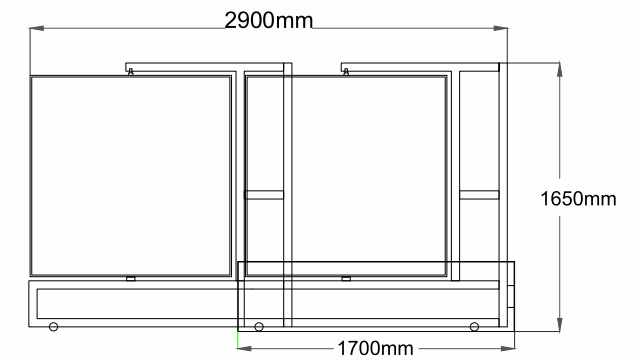

## 360° GULATIYA SERIES

CODE	STAND SIZE (H x L x W)	PANEL SIZE	TILE SIZE (L x W x T)	TILES QTY.	WEIGHT (KG)
M001	1750 x 600 x 1100	600 x 1200		10	100
	2150 x 600 x 1500	1000 x 1000		10	120
	1750 x 600 x 1700	1200 x 1200		10	140



# 360° GULATIYA STANDS



# 360° GULATIYA STANDS

## MATERIAL DETAILS

**TYPE :** MS PIPE & SHEET

**COATING :** POWDER COATING

**PANEL PIPE :** 20 X 20 X 1.2 MM

**OUTER BODY FRAME PIPE :** 50 X 50 X 1.2 MM

**COLOUR**



TOP VIEW

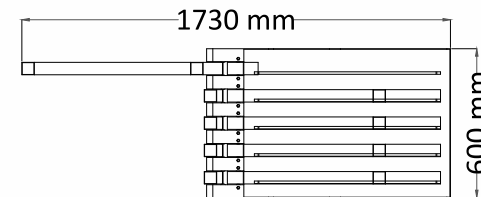

SIDE VIEW

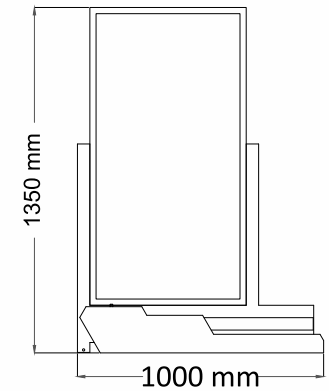

## 360° GULATIYA SERIES

CODE	STAND SIZE (H x L x W)	PANEL SIZE	TILE SIZE (L x W x T)	TILES QTY.	WIEGHT (KG)
M001	1750 x 600 x 1070	-	600 x 1200 x 09	10	70
	1350 x 600 x 1230	-	800 x 800 x 09	10	70
	2150 x 600 x 1230	-	800 x 1600 x 09	10	90
	1550 x 600 x 1400	-	1000 x 1000 x 09	10	80
	1750 x 600 x 1600	-	1200 x 1200 x 09	10	110



# 360° GULATIYA STANDS



# 360° GULATIYA STANDS

## MATERIAL DETAILS

**TYPE :** MS PIPE & SHEET

**COATING :** POWDER COATING

**PANEL PIPE :** 20 X 20 X 1.2 MM

**OUTER BODY FRAME PIPE :** 50 X 50 X 1.2 MM

**WEIGHT :** 80 KG ( APPROX )

**COLOUR**



TOP VIEW

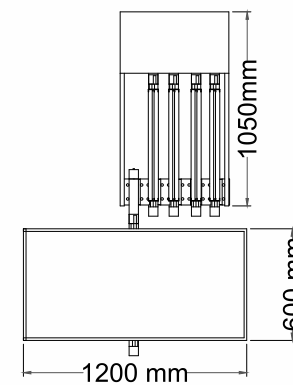

SIDE VIEW

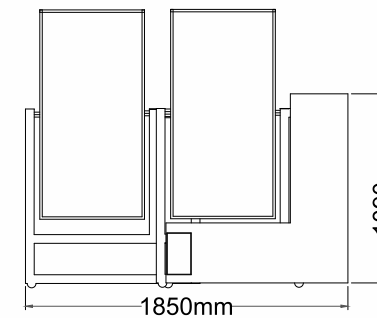

FRONT VIEW

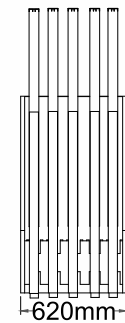

## 360° GULATIYA SERIES

CODE	STAND SIZE (H x L x W)	PANEL SIZE	TILE SIZE (L x W x T)	TILES QTY.	WEIGHT (KG)
M001	1750 x 600 x 1050	-	600 x 1200	10	80
	2150 x 600 x 2350	-	800 x 1600	10	110
	1550 x 600 x 1450	-	1000 x 1000	10	95
	1750 x 600 x 1650	-	1200 x 1200	10	120

**CHEMICAL**



**SHOWCASE OF BEST PRODUCT**

POWERFUL DISPLAY THAT GRABS ATTENTION

[www.momaitilesdisplay.com](http://www.momaitilesdisplay.com)



# CHEMICAL STANDS

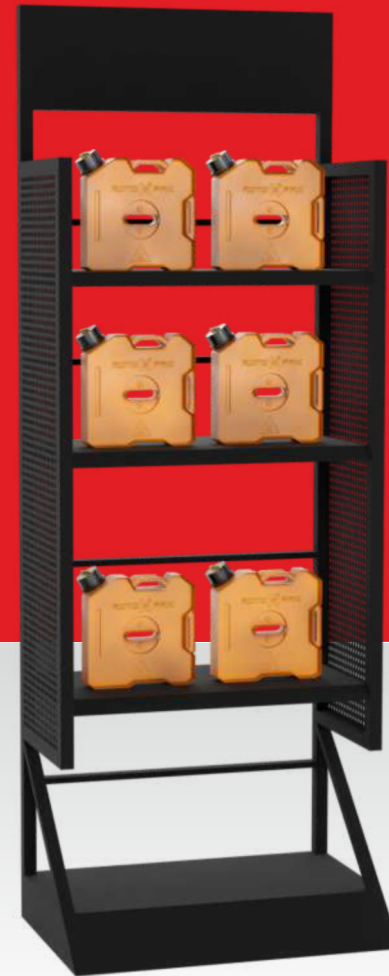

# CHEMICAL STANDS

## MATERIAL DETAILS

**TYPE :** MS SHEET & PIPES

**COATING :** POWDER COATING

**OUTER BODY FRAME PIPE :** 25 X 25 X 1.2 MM

**COLOUR**



FRONT VIEW

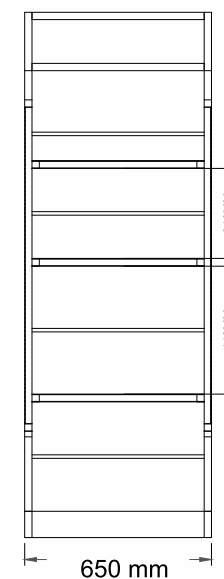

SIDE VIEW

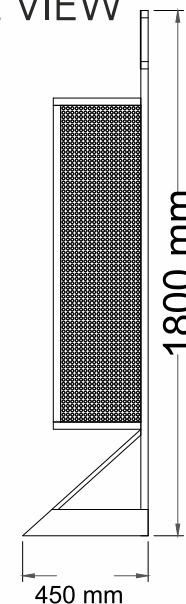

## CHEMICAL RACK SERIES

CODE	STAND SIZE (H x L x W)	PANEL SIZE	TILE SIZE (L x W x T)	TILES QTY.	WEIGHT (KG)
M001	1800 x 650 x 450	-	-	-	25



# CHEMICAL STANDS



# CHEMICAL STANDS

## MATERIAL DETAILS

TYPE : MS SHEET

MS PLATE : 1.5 MM

COATING : POWDER COATING

COLOUR



FRONT VIEW    SIDE VIEW

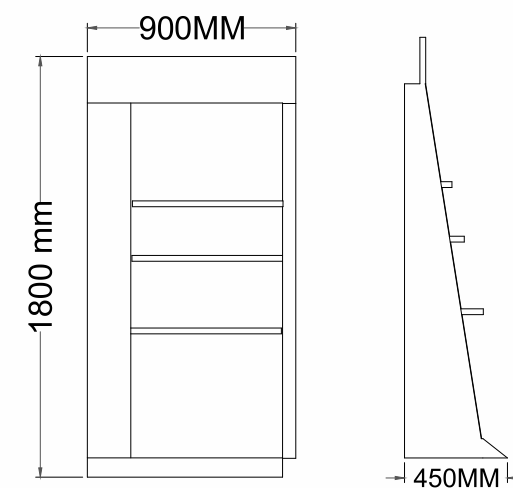

## CHEMICAL RACK SERIES

CODE	STAND SIZE (H x L x W)	PANEL SIZE	TILE SIZE (L x W x T)	TILES QTY.	WIEGHT (KG)
M001	1800 x 900 x 450	-	-	-	40



# CHEMICAL STANDS



# CHEMICAL STANDS

## MATERIAL DETAILS

TYPE : MS SHEET & MDF

OUTER BODY FRAME PIPE : 25 X 25 X 1.5 MM

COATING : POWDER COATING

COLOUR



SIDE VIEW

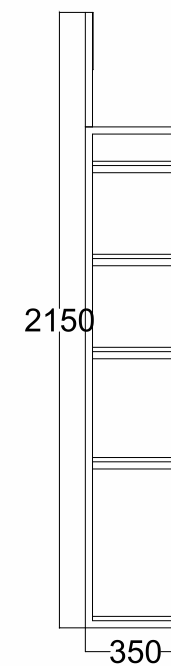

FRONT VIEW

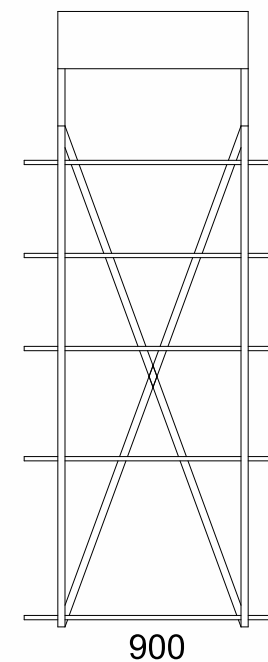

## CHEMICAL RACK SERIES

CODE	STAND SIZE (H x L x W)	PANEL SIZE	TILE SIZE (L x W x T)	TILES QTY.	WEIGHT (KG)
M001	2150 x 900 x 350	-	-	-	20



# CHEMICAL STANDS



# CHEMICAL STANDS

## MATERIAL DETAILS

TYPE : MS

OUTER BODY FRAME PIPE : 25 X 25 X 1.2 MM

COATING : POWDER COATING

WEIGHT : POWDER COATING

COLOUR



FRONT VIEW

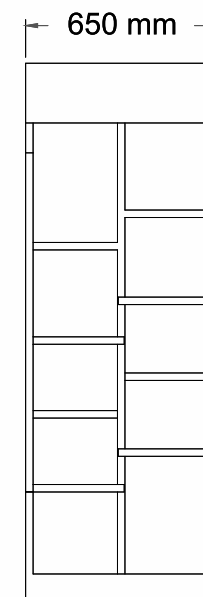

SIDE VIEW

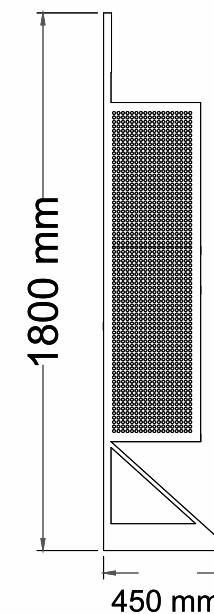

## CHEMICAL RACK SERIES

CODE	STAND SIZE (H x L x W)	PANEL SIZE	TILE SIZE (L x W x T)	TILES QTY.	WEIGHT (KG)
M001	1800 x 650 x 450	-	-	-	30

**STONE**



**SHOWCASE OF BEST PRODUCT**

POWERFUL DISPLAY THAT GRABS ATTENTION

[www.momaitilesdisplay.com](http://www.momaitilesdisplay.com)



# STONE STANDS



# STONE STANDS

## MATERIAL DETAILS

TYPE : MS

COATING : POWDER COATING

OUTER BODY FRAME PIPE : 40 X 40 X 1.2 MM

COLOUR

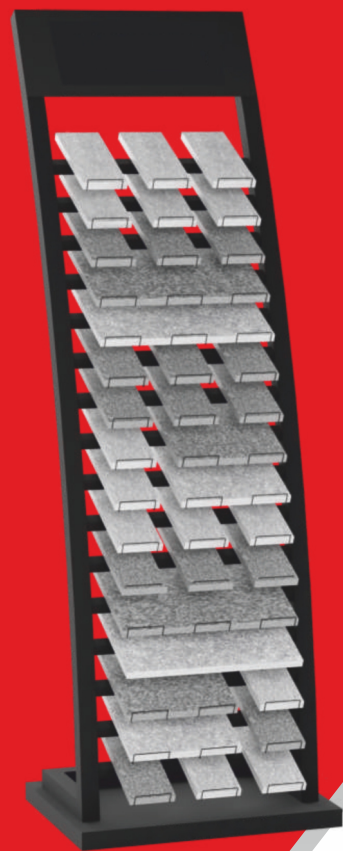

FRONT VIEW

SIDE VIEW

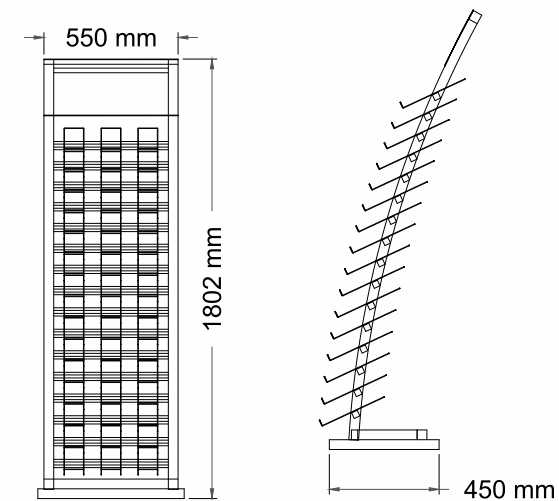

## SLAB SAMPLE SERIES

CODE	STAND SIZE (H x L x W)	PANEL SIZE	TILE SIZE (L x W x T)	TILES QTY.	WEIGHT (KG)
M001	1800 x 450 x 550	-	100 x 200 x 15	45	50
			150 x 300 x 15		



# STONE STANDS



# STONE STANDS

## MATERIAL DETAILS

TYPE : MS PIPE

COATING : POWDER COATING

OUTER BODY FRAME PIPE : 40 X 40 X 1.2 MM

COLOUR



FRONT VIEW

SIDE VIEW

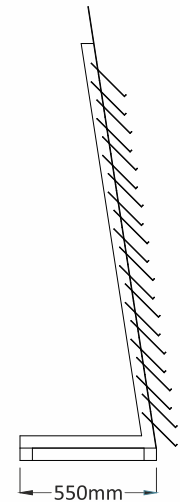
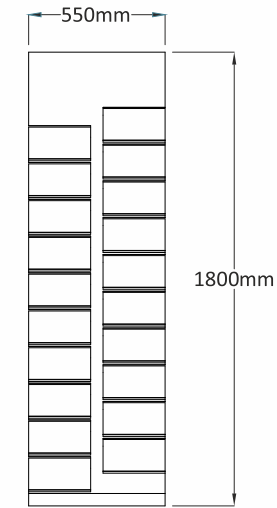

## SLAB SAMPLE SERIES

CODE	STAND SIZE (H x L x W)	PANEL SIZE	TILE SIZE (L x W x T)	TILES QTY.	WEIGHT (KG)
M001	1800 x 550 x 550	-	100 x 200 x 15	20	50
			150 x 300 x 15		
			250 x 250 x 15		



# STONE STANDS

# STONE STANDS



## MATERIAL DETAILS

**TYPE :** MS PIPE

**COATING :** POWDER COATING

**OUTER BODY FRAME PIPE :** 40 X 40 X 1.2 MM

**COLOUR**



## FRONT VIEW

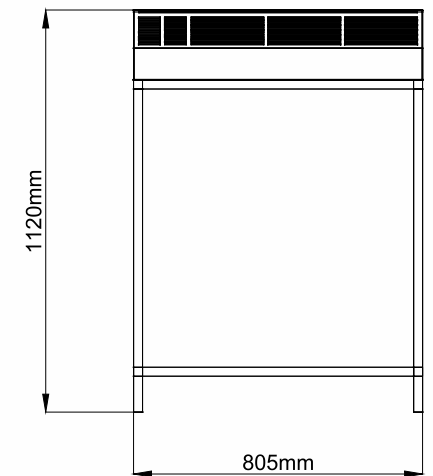

## SLAB SAMPLE SERIES

CODE	STAND SIZE (H x L x W)	PANEL SIZE	TILE SIZE (L x W x T)	TILES QTY.	WEIGHT (KG)
M001	1150 x 800 x 1500	-	-	-	30



# STONE STANDS



# STONE STANDS

## MATERIAL DETAILS

**TYPE :** MS PIPE & SHEET

**COATING :** POWDER COATING

**OUTER BODY FRAME PIPE :** 40 X 40 X 1.2 MM

**COLOUR**



SIDE VIEW

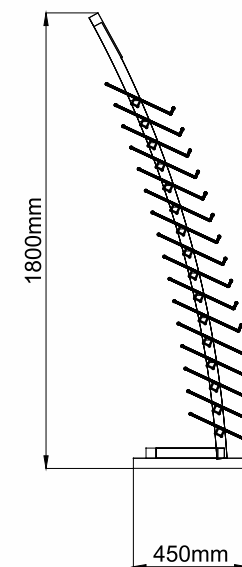

FRONT VIEW

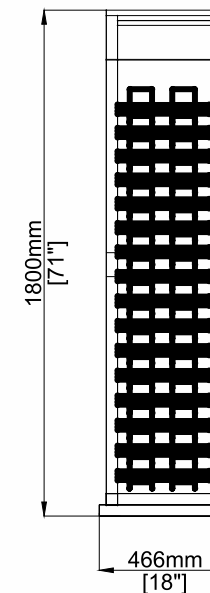

## SLAB SAMPLE SERIES

CODE	STAND SIZE (H x L x W)	PANEL SIZE	TILE SIZE (L x W x T)	TILES QTY.	WIEIGHT (KG)
M001	1800 x 550 x 450	-	100 * 200 x 15	30	30
			150 x 300 x 15		
			250 * 250 * 15		



# STONE STANDS



# STONE STANDS

## MATERIAL DETAILS

TYPE : MS PIPE

COATING : POWDER COATING

OUTER BODY FRAME PIPE : 40 X 40 X 1.2 MM

COLOUR



SIDE VIEW

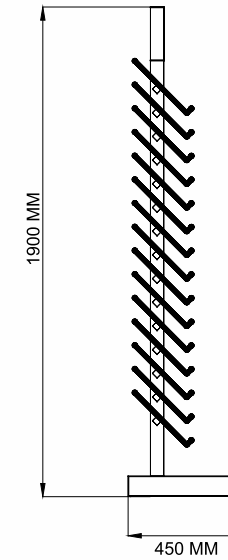

FRONT VIEW

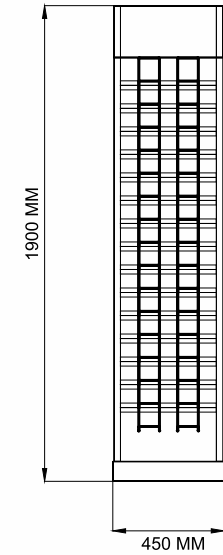

## SLAB SAMPLE SERIES

CODE	STAND SIZE (H x L x W)	PANEL SIZE	TILE SIZE (L x W x T)	TILES QTY.	WEIGHT (KG)
M001	1900 x 435 x 435	-	100 x 200 x 15	30	20
			150 x 300 x 15		
			250 x 250 x 15		



# STONE STANDS



# STONE STANDS

## MATERIAL DETAILS

TYPE : MS PIPE

COATING : POWDER COATING

OUTER BODY FRAME PIPE : 40 X 40 X 1.2 MM

COLOUR



SIDE VIEW

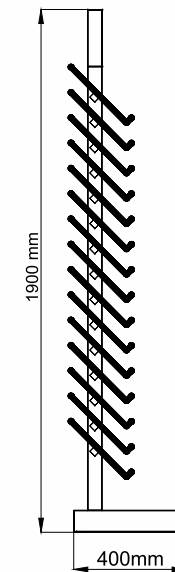

FRONT VIEW

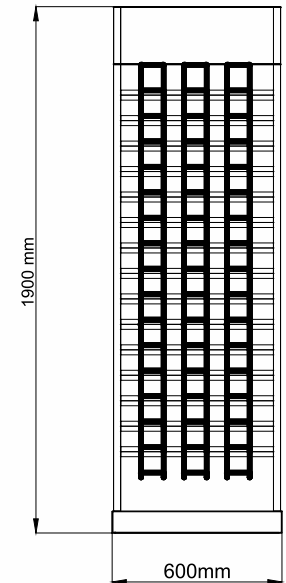

## SLAB SAMPLE SERIES

CODE	STAND SIZE (H x L x W)	PANEL SIZE	TILE SIZE (L x W x T)	TILES QTY.	WEIGHT (KG)
M001	1900 x 600 x 400	-	100 x 200 x 15	45	50
			150 x 300 x 15		
			250 x 250 x 15		

# CATALOG



## SHOWCASE OF YOUR CATALOG

POWERFUL DISPLAY THAT GRABS ATTENTION

[www.momaitilesdisplay.com](http://www.momaitilesdisplay.com)



# CATALOG STANDS



# CATALOG STANDS

## MATERIAL DETAILS

**TYPE :** MS PIPE & SHEET

**MDF THICKNESS :** 12 MM

**COATING :** POWDER COATING

**WEIGHT :** 18 KG ( APPROX )

**COLOUR**



FRONT VIEW

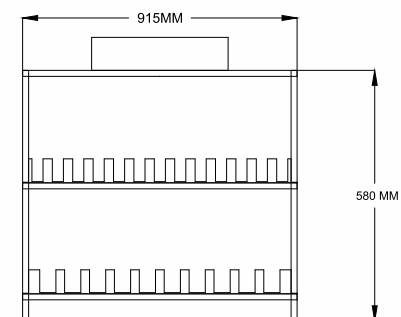

SIDE VIEW

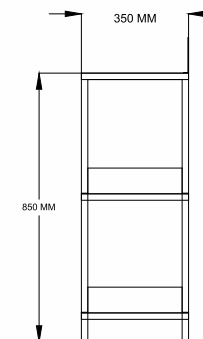

## CATALOG SERIES

CODE	STAND SIZE (H x L x W)	PANEL SIZE	TILE SIZE (L x W x T)	TILES QTY.	WEIGHT (KG)
	835 x 915 x 333	-	-	-	18

## MINI BOOKLET

STANDS

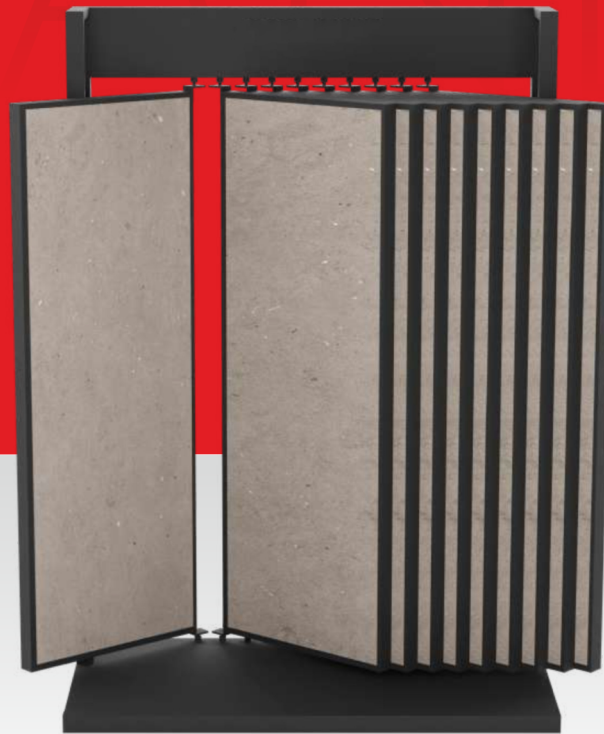

## VARIOUS TILES AT BOOK

POWERFUL DISPLAY THAT GRABS ATTENTION

[www.momaitilesdisplay.com](http://www.momaitilesdisplay.com)



# MINI BOOKLET STANDS

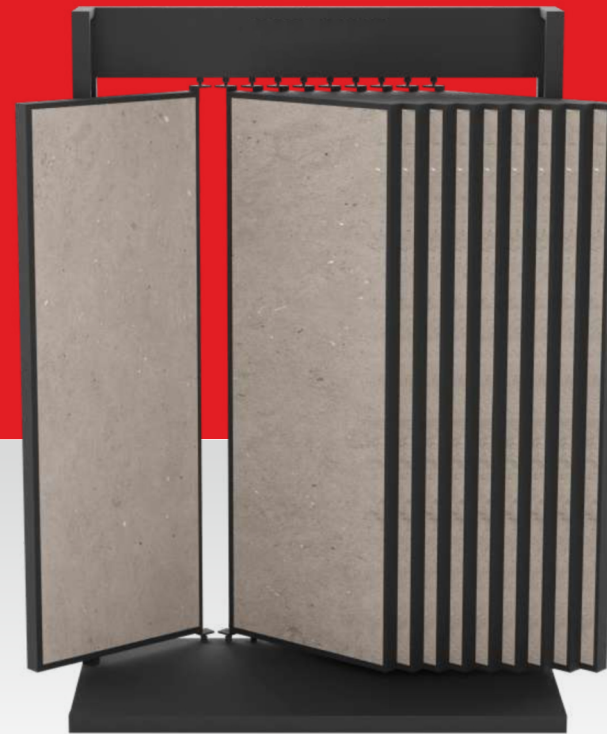

# MINI BOOKLET STANDS

## MATERIAL DETAILS

TYPE : MS PIPE & SHEET

OUTER BODY STRUCTURE PIPE : 50 X 50 MM

PLATE THICKNESS : 1.2 MM

COATING : POWDER COATING

### COLOUR



FRONT VIEW

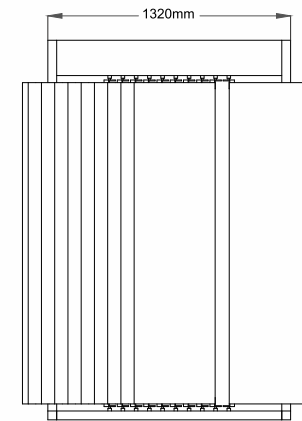

SIDE VIEW

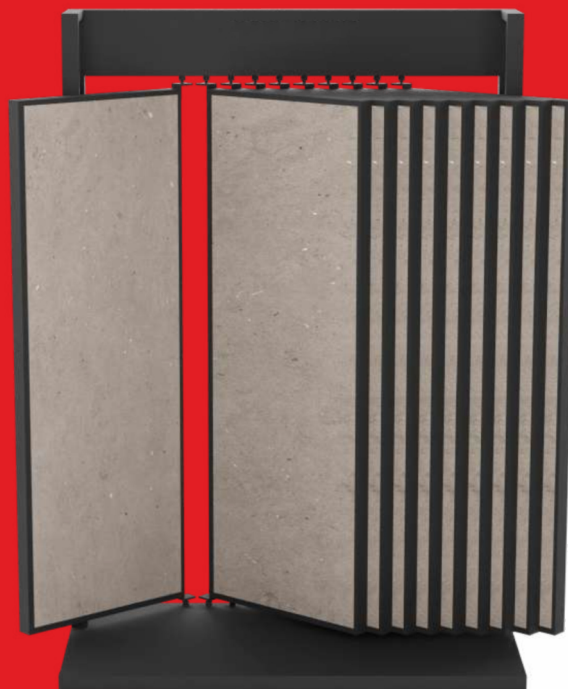
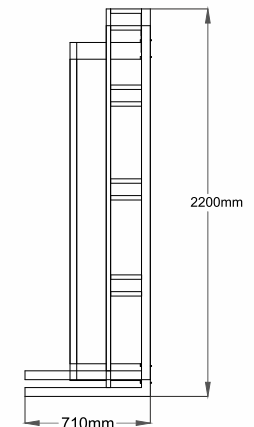

## BOOKLET SERIES

CODE	STAND SIZE (H x L x W)	PANEL SIZE	TILE SIZE (L x W x T)	TILES QTY.	WEIGHT (KG)
M001	2195 x 1375 x 710	600 x 1200	600 x 1200 x 9	10	50
M002	2195 x 1800 x 710	600 x 1200	600 x 1200 x 9	15	70
M003	2600 x 1320 x 710	800 x 1600	800 x 1600 x 9	10	65
M004	2600 x 1800 x 710	800 x 1600	800 x 1600 x 9	15	90



# MINI BOOKLET STANDS

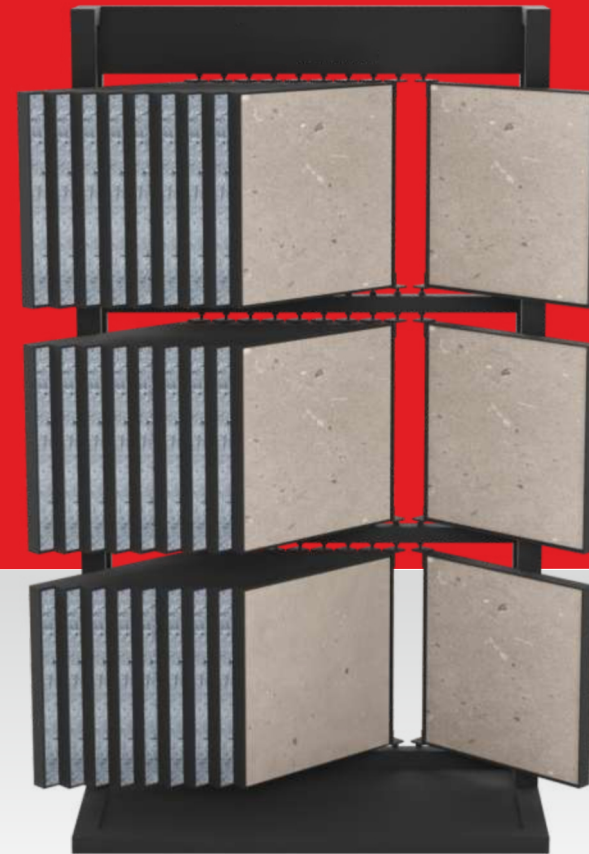

# MINI BOOKLET STANDS

## MATERIAL DETAILS

**TYPE :** MS PIPE

**OUTER BODY STRUCTURE PIPE :** 50 X 50 MM

**PLATE THICKNESS :** 1.2 MM

**COATING :** POWDER COATING

**WEIGHT :** 88 KG ( APPROX )

**COLOUR**



FRONT VIEW

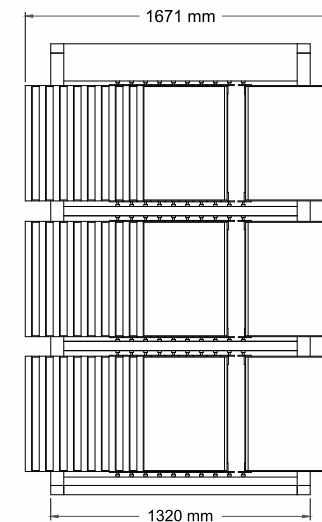

SIDE VIEW

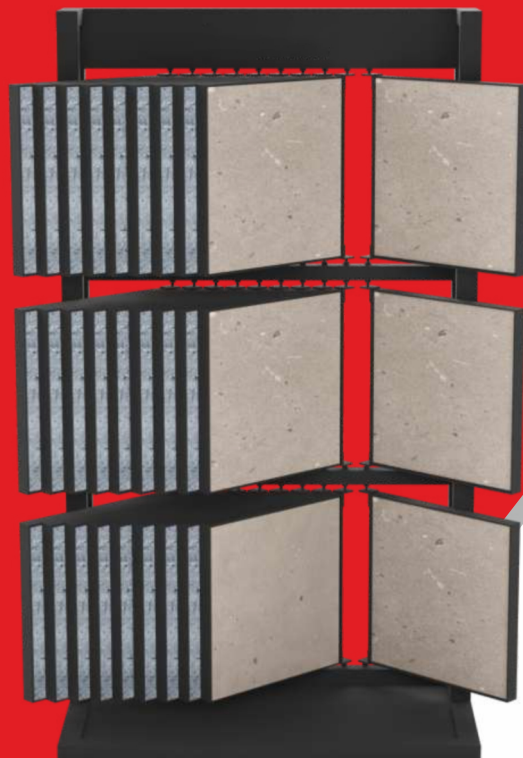
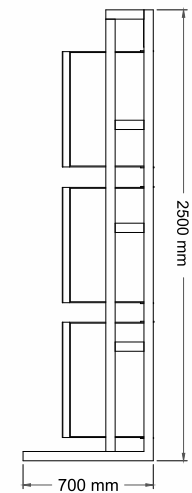

## BOOKLET SERIES

CODE	STAND SIZE (H x L x W)	PANEL SIZE	TILE SIZE (L x W x T)	TILES QTY.	WEIGHT (KG)
M001	2500 x 1320 x 700	600 x 600	600 x 600 x 9	60	80



# MINI BOOKLET STANDS



# MINI BOOKLET STANDS

## MATERIAL DETAILS

**TYPE :** MS PIPE & SHEET

**OUTER BODY STRUCTURE PIPE :** 50 X 50 MM

**PLATE THICKNESS :** 1.2 MM

**COATING :** POWDER COATING

**COLOUR**



FRONT VIEW

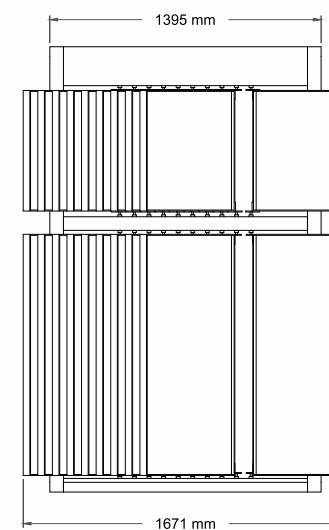

SIDE VIEW

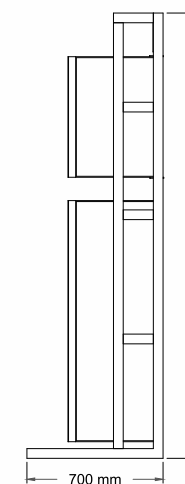

## BOOKLET SERIES

CODE	STAND SIZE (H x L x W)	PANEL SIZE	TILE SIZE (L x W x T)	TILES QTY.	WEIGHT (KG)
M001	2290 x 1671 x 700	600 x 600	600 x 600 x 9	20	80
		600 x 1200	600 x 1200 + 9	20	



# MINI BOOKLET STANDS

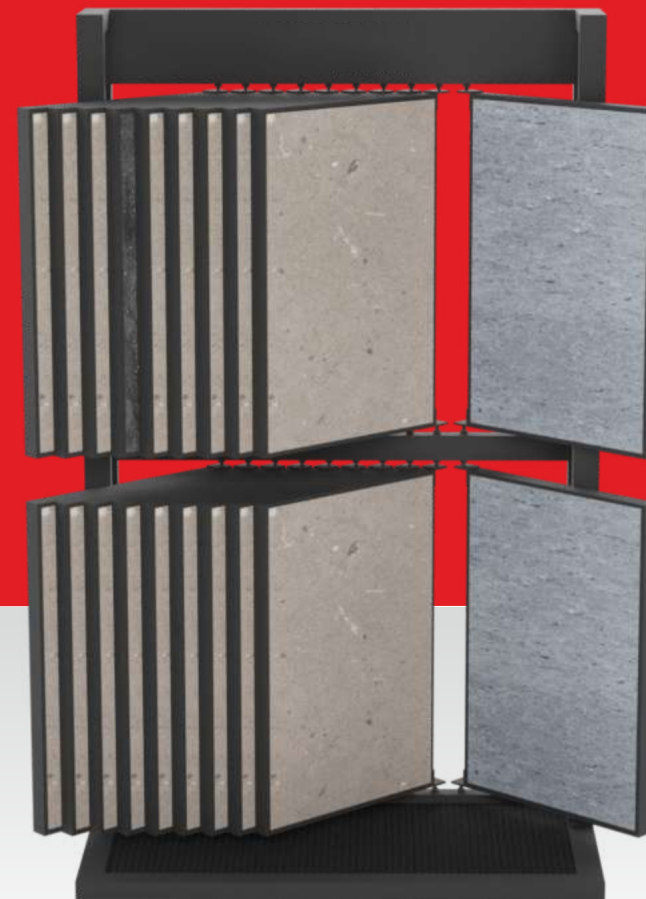

# MINI BOOKLET STANDS



## MATERIAL DETAILS

**TYPE :** MS PIPE & SHEET

**OUTER BODY STRUCTURE PIPE :** 50 X 50 MM

**PLATE THICKNESS :** 1.2 MM

**COATING :** POWDER COATING

**COLOUR**

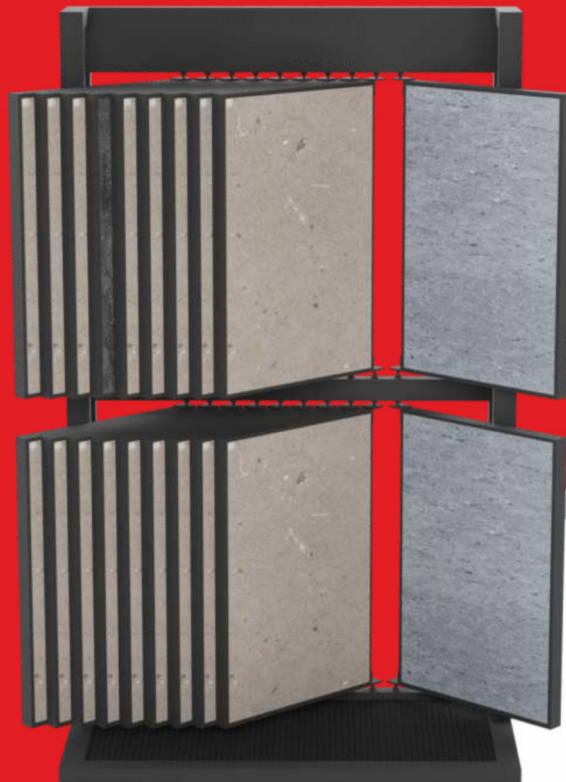

FRONT VIEW

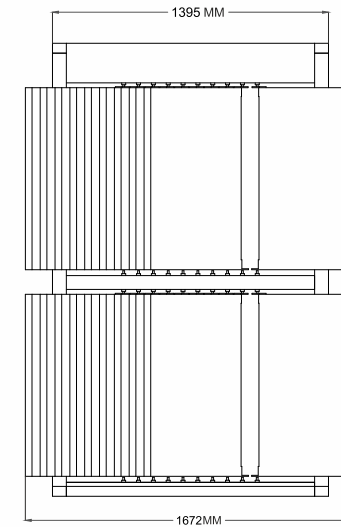

SIDE VIEW

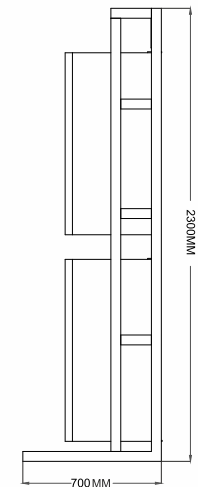

## BOOKLET SERIES

CODE	STAND SIZE (H x L x W)	PANEL SIZE	TILE SIZE (L x W x T)	TILES QTY.	WEIGHT (KG)
M001	2290 x 1672 x 700	600 x 1200	600 x 1200 x 9	20	80
		600 x 1200	600 x 1200 x 9	20	



# MINI BOOKLET STANDS



# MINI BOOKLET STANDS

## MATERIAL DETAILS

TYPE : MS PIPE

OUTER BODY STRUCTURE PIPE : 100 X 50 X 3 MM

PANEL PIPE : 50 X 25 X 1.2 MM

COATING : POWDER COATING

COLOUR



FRONT VIEW

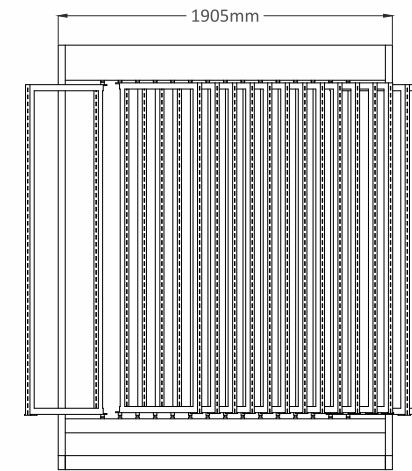

SIDE VIEW

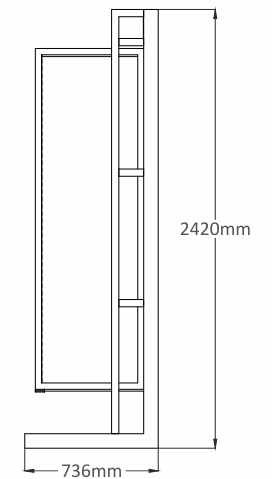

## BOOKLET SERIES

CODE	STAND SIZE (H x L x W)	PANEL SIZE	TILE SIZE (L x W x T)	TILES QTY.	WEIGHT (KG)
M001	2770 x 1400 x 600	-	300 x 300 x 09	12	100
			400 * 400 x 09		
			300 * 600 * 09		
			600 * 1200 * 09		
			1200 x 1200 * 09		
			1200 * 2400 * 09		



# MINI BOOKLET STANDS



# MINI BOOKLET STANDS

## MATERIAL DETAILS

**TYPE :** MS PIPE

**OUTER BODY STRUCTURE PIPE :** 100 X 50 X 3 MM

**PANEL PIPE :** 50 X 25 X 1.2 MM

**COATING :** POWDER COATING

**COLOUR**



FRONT VIEW

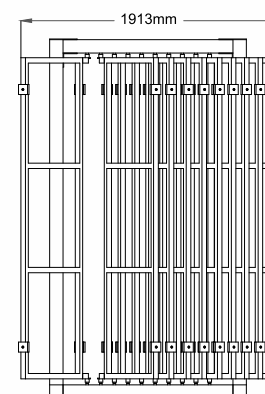

FRONT VIEW

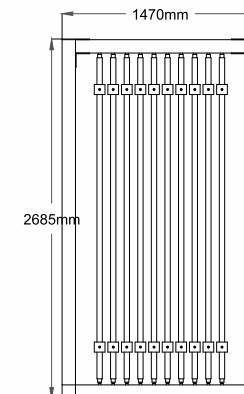

SIDE VIEW

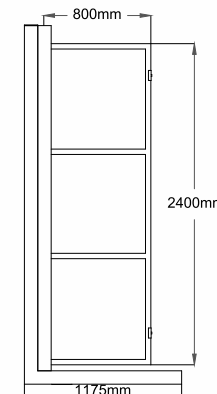

## BOOKLET SERIES

CODE	STAND SIZE (H x L x W)	PANEL SIZE	TILE SIZE (L x W x T)	TILES QTY.	WEIGHT (KG)
M001	2770 x 1400 x 3400	-	800 x 2400 x 20		1000
			800 x 2600 x 20		
			800 x 2800 x 20		
			800 x 3000 x 20		
			800 x 3200 x 20		





📍 Plot No. 48, Survey No. 597p, Flora Estate, Ghuntu Road, Ghutu,  
Morbi - 363 642

✉ [info@momaitilesdisplay.com](mailto:info@momaitilesdisplay.com)    🌐 [www.momaitilesdisplay.com](http://www.momaitilesdisplay.com)

