



DISPLAYS THAT DO THE TALKING.

www.momaitilesdisplay.com

About Us

Momai Tiles Display is a trusted manufacturer of modern and durable tile display stands for showrooms and retail spaces. We create smart and functional display solutions that help businesses present tiles in an organized and attractive way. Our focus on quality, innovation, and customer satisfaction allows us to deliver reliable products for the ceramic industry.

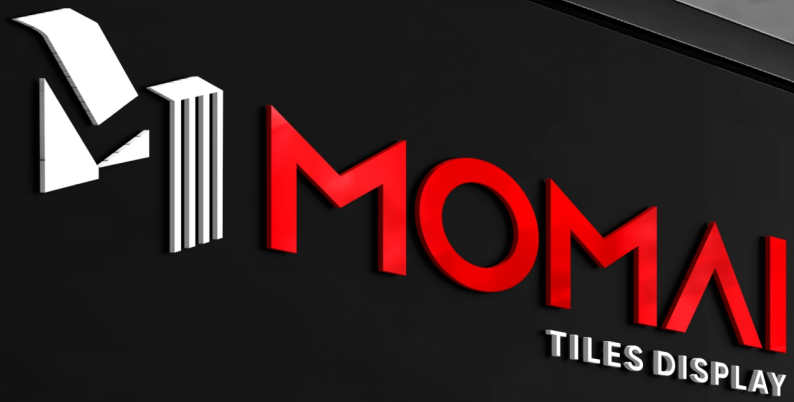

Vision

At Momai Tiles Display, our vision is to become a trusted global leader in innovative tile display stand manufacturing by delivering modern, durable, and visually impactful display solutions that elevate showroom experiences. We aim to help tile brands, retailers, and distributors present their products with elegance, efficiency, and professionalism while continuously setting new standards in design, quality, and functionality.

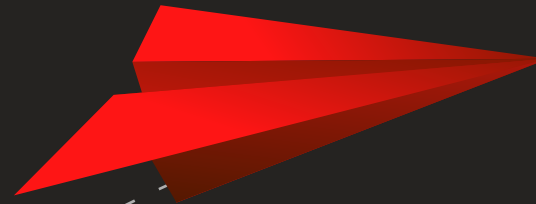

Mission

Our mission is to manufacture high-quality tile display stands that combine strength, smart engineering, and aesthetic appeal to meet the evolving needs of the ceramic and tile industry. We are committed to providing customized solutions, reliable service, timely delivery, and long-term value to our clients while building strong relationships through innovation, craftsmanship, and customer satisfaction.

MOCKUP

STANDS



MASSIVE STRUCTURE

POWERFUL DISPLAY THAT GRABS ATTENTION

www.momaitilesdisplay.com



MOCKUP STANDS



MOCKUP STANDS



MATERIAL DETAILS

TYPE : MS PIPE & PLYWOOD + CARPET
OUTER BODY FRAME PIPE : 50 X 50 X 1.2 MM
COATING : POWDER COATING
WEIGHT : 250 KG (APPROX.)

COLOUR



SIDE VIEW

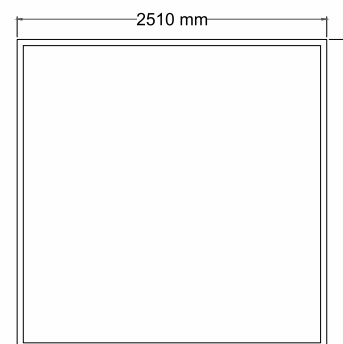

TOP VIEW

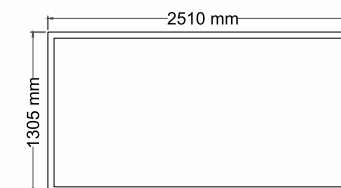

MOCKUP SERIES

CODE	STAND SIZE (H x L x W)	PANEL SIZE	TILE SIZE (L x W x T)	TILES QTY.	WEIGHT (KG)
M001	2510 x 2510 x 1305	-	600 x 1200 x 09	10	250
			800 x 1600 * 09		
			1200 x 1800 * 09		
			1200 x 2400 * 09		



MOCKUP STANDS



MOCKUP STANDS

MATERIAL DETAILS

TYPE : MS PIPE & PLYWOOD + CARPET

COATING : POWDER COATING

OUTER BODY FRAME PIPE : 50 X 50 X 1.2 MM

COLOUR



SIDE VIEW

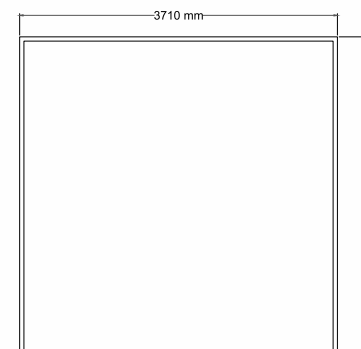

TOP VIEW

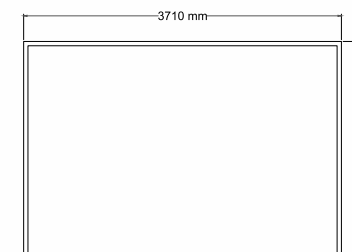

MOCKUP SERIES

CODE	STAND SIZE (H x L x W)	PANEL SIZE	TILE SIZE (L x W x T)	TILES QTY.	WEIGHT (KG)
M001	2510 x 3710 x 3710	-	600 x 1200 x 09	10	400
			800 x 1600 x 09		
			1200 x 1800 x 09		
			1200 x 2400 x 09		



MOCKUP STANDS



MOCKUP STANDS

MATERIAL DETAILS

TYPE : MS PIPE + PLYWOOD + CARPET

COATING : POWDER COATING

OUTER BODY FRAME PIPE : 50 X 50 X 1.2 MM

COLOUR



SIDE VIEW

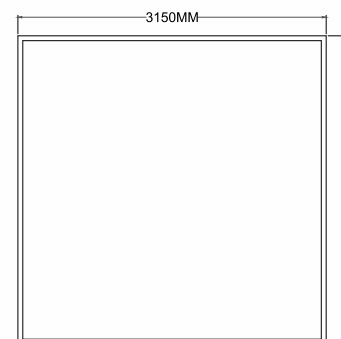

TOP VIEW

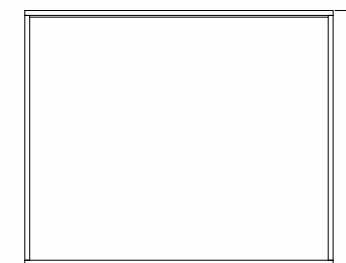

MOCKUP SERIES

CODE	STAND SIZE (H x L x W)	PANEL SIZE	TILE SIZE (L x W x T)	TILES QTY.	WEIGHT (KG)
M001	2630 x 3150 x 3150	-	600 x 1200 x 09	10	350
			800 x 1600 x 09		
			1200 x 1800 x 09		
			1200 x 2400 x 09		



MOCKUP STANDS



MOCKUP STANDS

MATERIAL DETAILS

TYPE : MS PIPE + PLYWOOD + CARPET

COATING : POWDER COATING

OUTER BODY FRAME PIPE : 50 X 50 X 1.2 MM

COLOUR



FRONT VIEW

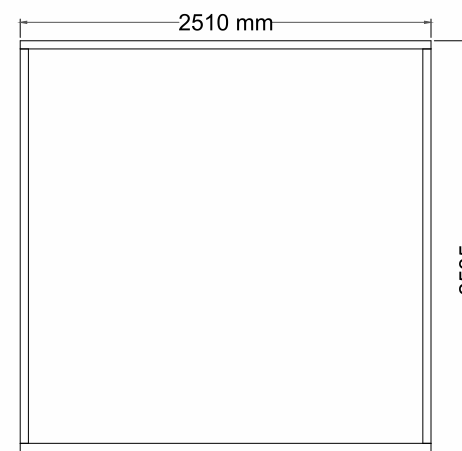

SIDE VIEW

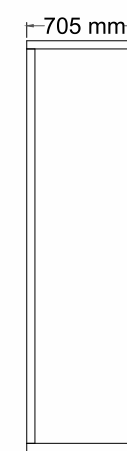

MOCKUP SERIES

CODE	STAND SIZE (H x L x W)	PANEL SIZE	TILE SIZE (L x W x T)	TILES QTY.	WEIGHT (KG)
M001	2535 x 2510 x 705	-	600 x 1200 x 09	10	130
			800 x 1600 x 09		
			1200 x 1800 x 09		
			1200 x 2400 x 09		



MOCKUP STANDS



MOCKUP STANDS

MATERIAL DETAILS

TYPE : MS PIPE + PLYWOOD + CARPET

OUTER BODY FRAME PIPE : 50 X 50 X 1.2 MM

COATING : POWDER COATING

WEIGHT : 300 KG (APPROX)

COLOUR



FRONT VIEW

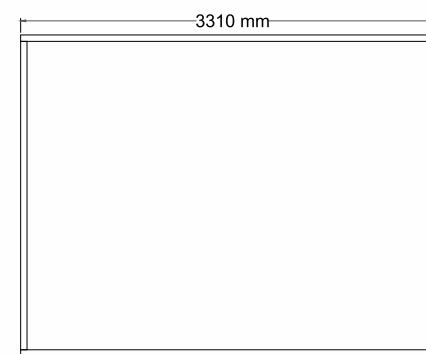

SIDE VIEW

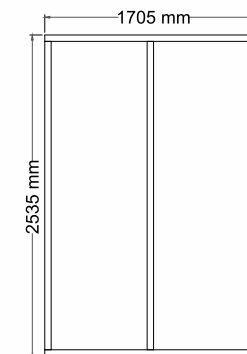

MOCKUP SERIES

CODE	STAND SIZE (H x L x W)	PANEL SIZE	TILE SIZE (L x W x T)	TILES QTY.	WEIGHT (KG)
M001	2535 x 3310 x 1705	-	600 x 1200 x 09	10	300
			800 x 1600 x 09		
			1200 x 1800 x 09		
			1200 x 2400 x 09		



MOCKUP STANDS



MOCKUP STANDS

MATERIAL DETAILS

TYPE : MS PIPE + PLYWOOD + CARPET

OUTER BODY FRAME PIPE : 50 X 50 X 1.2 MM

COATING : POWDER COATING

WEIGHT : 300 KG (APPROX)

COLOUR



FRONT VIEW

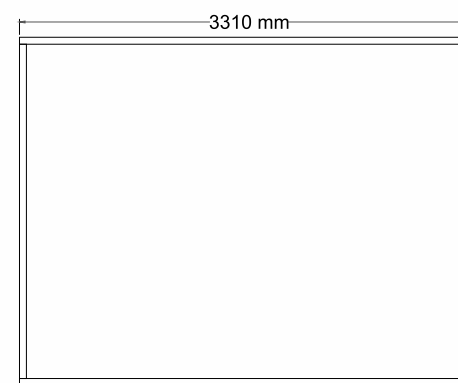

SIDE VIEW

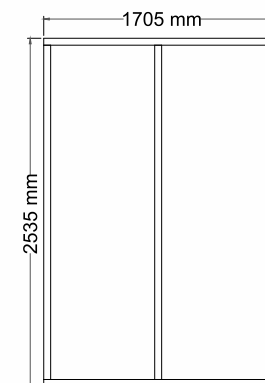

MOCKUP SERIES

CODE	STAND SIZE (H x L x W)	PANEL SIZE	TILE SIZE (L x W x T)	TILES QTY.	WEIGHT (KG)
M001	2535 x 3310 x 1705	-	600 x 1200 x 09	10	170
			800 x 1600 x 09		
			1200 x 1800 x 09		
			1200 x 2400 x 09		



MOCKUP STANDS



MOCKUP STANDS

MATERIAL DETAILS

TYPE : MS PIPE + PLYWOOD + CARPET
OUTER BODY FRAME PIPE : 50 X 50 X 1.2 MM
COATING : POWDER COATING
WEIGHT : 250 KG (APPROX)

COLOUR



FRONT VIEW

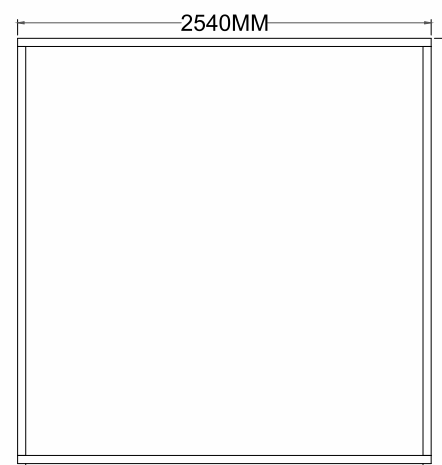

SIDE VIEW

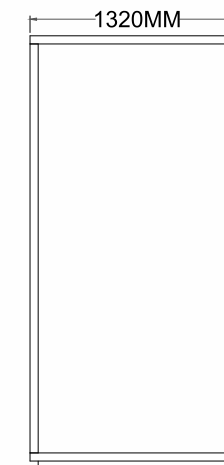

MOCKUP SERIES

CODE	STAND SIZE (H x L x W)	PANEL SIZE	TILE SIZE (L x W x T)	TILES QTY.	WEIGHT (KG)
M001	2640 x 2540 x 1320	-	600 x 1200 x 09	10	250
			800 x 1600 x 09		
			1200 x 1800 x 09		
			1200 x 2400 x 09		



MOCKUP STANDS



MOCKUP STANDS



MATERIAL DETAILS

TYPE : MS PIPE + PLYWOOD + CARPET

OUTER BODY FRAME PIPE : 50 X 50 X 1.2 MM

COATING : POWDER COATING

COLOUR



SIDE VIEW

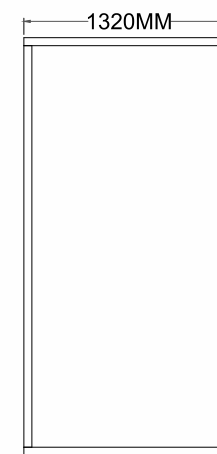

FRONT VIEW

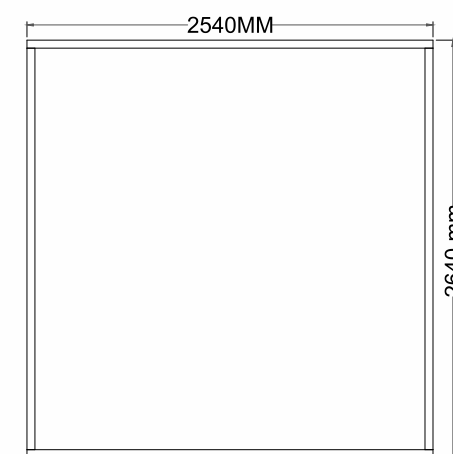

MOCKUP SERIES

CODE	STAND SIZE (H x L x W)	PANEL SIZE	TILE SIZE (L x W x T)	TILES QTY.	WEIGHT (KG)
M001	2640 x 2540 x 1320	-	600 x 1200 x 09	10	160
			800 x 1600 x 09		
			1200 x 1800 * 09		
			1200 x 2400 * 09		



MOCKUP STANDS



MOCKUP STANDS



MATERIAL DETAILS

TYPE : MS PIPE + PLYWOOD + CARPET

OUTER BODY FRAME PIPE : 50 X 50 X 1.2 MM

COATING : POWDER COATING

WEIGHT : 400 KG (APPROX)

COLOUR



FRONT VIEW

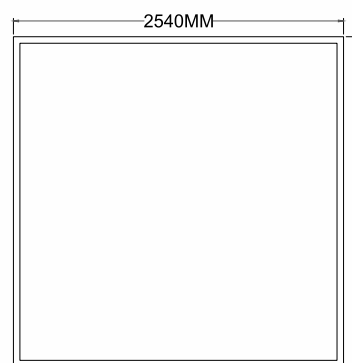

SIDE VIEW

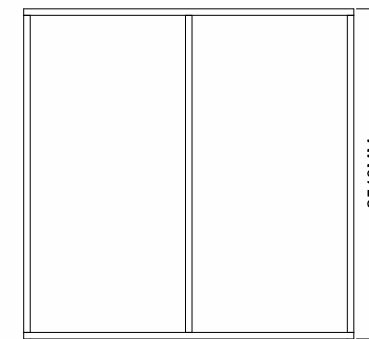

MOCKUP SERIES

CODE	STAND SIZE (H x L x W)	PANEL SIZE	TILE SIZE (L x W x T)	TILES QTY.	WEIGHT (KG)
M001	2540 x 2540 x 2540	-	600 x 1200 x 09	10	400
			800 x 1600 x 09		
			1200 x 1800 x 09		
			1200 x 2400 x 09		



MOCKUP STANDS



MOCKUP STANDS

MATERIAL DETAILS

TYPE : MS PIPE + PLYWOOD + CARPET

OUTER BODY FRAME PIPE : 50 X 50 X 1.2 MM

COATING : POWDER COATING

WEIGHT : 400 KG (APPROX)

COLOUR



TOP VIEW

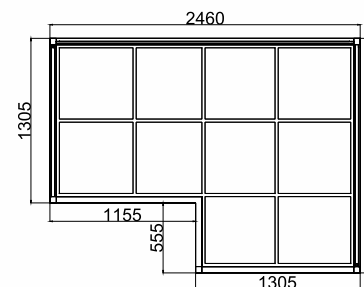

SIDE VIEW

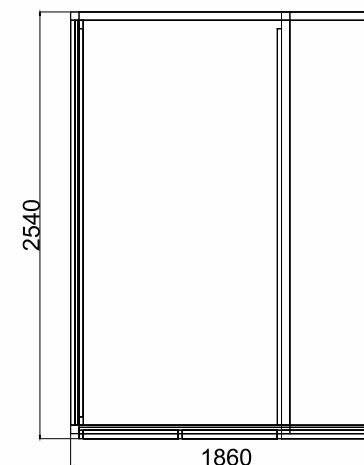

MOCKUP SERIES

CODE	STAND SIZE (H x L x W)	PANEL SIZE	TILE SIZE (L x W x T)	TILES QTY.	WEIGHT (KG)
M001	2540 x 2460 x 1860	-	600 x 1200 x 09	10	180
			800 x 1600 x 09		
			1200 + 1800 + 09		
			1200 + 2400 x 09		



MOCKUP STANDS



MOCKUP STANDS

MATERIAL DETAILS

TYPE : MS PIPE

OUTER BODY FRAME PIPE : 50 X 50 X 1.2 MM

COATING : POWDER COATING

COLOUR



SIDE VIEW

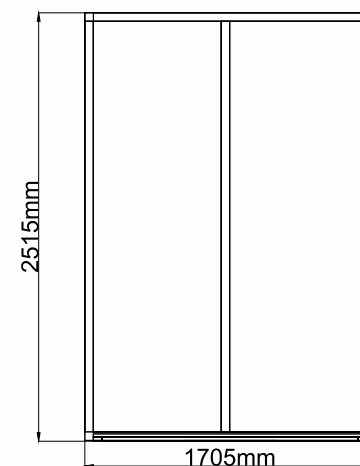

TOP VIEW

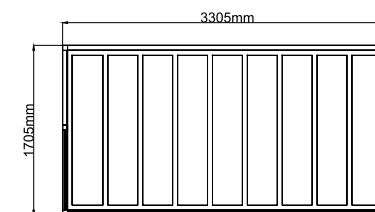

MOCKUP SERIES

CODE	STAND SIZE (H x L x W)	PANEL SIZE	TILE SIZE (L x W x T)	TILES QTY.	WEIGHT (KG)
M001	2520 x 3305 x 1705	-	800 x 2400 x 09	10	240



MOCKUP STANDS



MATERIAL DETAILS

TYPE : MS PIPE + PLYWOOD + CARPET
OUTER BODY FRAME PIPE : 50 X 50 X 1.2 MM
COATING : POWDER COATING

COLOUR



SIDE VIEW

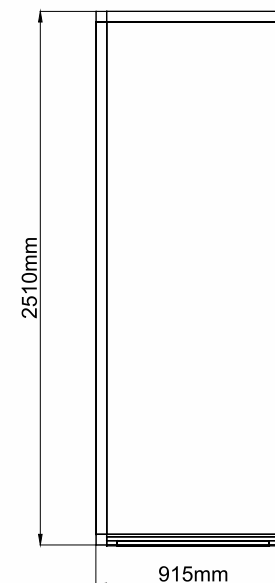

TOP VIEW

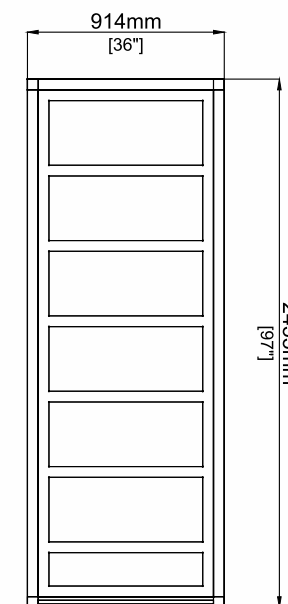

MOCKUP SERIES

CODE	STAND SIZE (H x L x W)	PANEL SIZE	TILE SIZE (L x W x T)	TILES QTY.	WEIGHT (KG)
M001	2510 x 2455 x 915	-	600 x 1200 x 09	10	120
			800 x 1600 x 09		
			1200 x 1800 x 09		
			1200 x 2400 x 09		



MOCKUP STANDS



MOCKUP STANDS

MATERIAL DETAILS

TYPE : MS PIPE + PLYWOOD + CARPET

OUTER BODY FRAME PIPE : 50 X 50 X 1.2 MM

COATING : POWDER COATING

COLOUR



SIDE VIEW

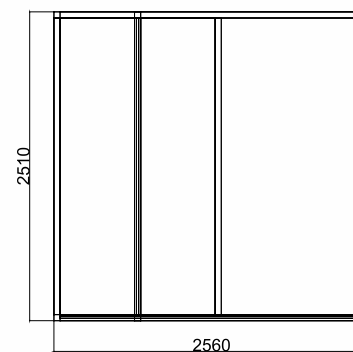

TOP VIEW

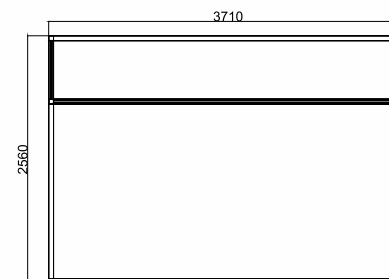

MOCKUP SERIES

CODE	STAND SIZE (H x L x W)	PANEL SIZE	TILE SIZE (L x W x T)	TILES QTY.	WEIGHT (KG)
M001	2510 x 3710 x 2560	-	600 x 1200 x 09	10	280
			800 x 1600 x 09		
			1200 x 1800 x 09		
			1200 x 2400 x 09		



📍 Plot No. 48, Survey No. 597p, Flora Estate, Ghuntu Road, Ghutu,
Morbi - 363 642

✉ info@momaitilesdisplay.com 🌐 www.momaitilesdisplay.com

